

FREEZER System

Refrigeration Specifications

LASJ105RCC3

Compressor	Air cooled Condensing Unit	Rack Size	Refrigerant
Scroll	208-230/60/3	A	R449A

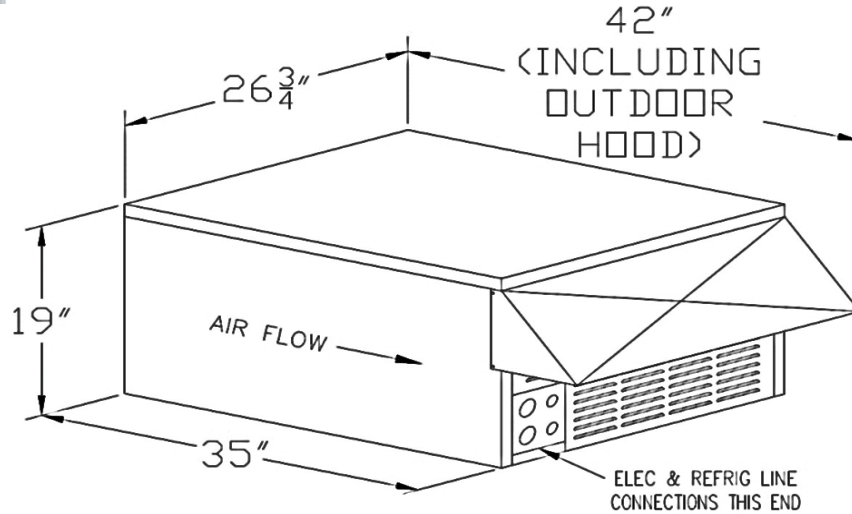

Condensing Unit MOP 15

Model #	HP	Electical Data		BTU Capacity	Connection sizes		Weight (lbs)
		MCA	MOP	Temp Setpoint -10° @ 100° Ambient	Liquid (in)	Suction (in)	
LASJ105RCC3	1	10.85	15	2,581	3/8	7/8	161

**Evaporator Unit Cooler
230/60/1**

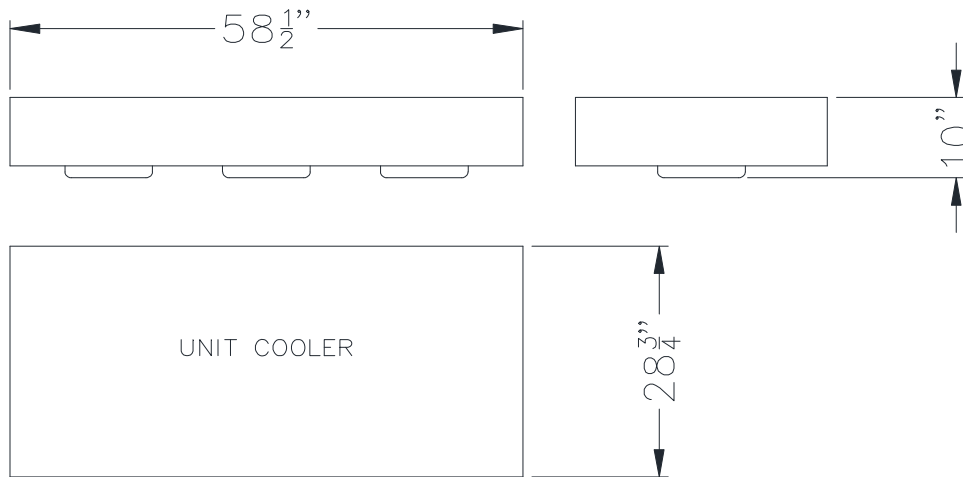

Evaporator MOP 20

Evaporator Specifications

Model #	Fan Qty	CFM	Electrical Data (1)			Connection sizes			Weight (lbs)
			MCA	MOP	Elec Defrost Amps	Liquid(in)	Suction(in)	Drain(in)	
DFE36-53DE-E	3	1530	12.12	20	9	1/2	5/8	3/4	95

Model# LASJ105RCC3 Heat of Rejection btu/hr 0	Cond part #	Nominal voltage	MCA	MOP	Weight
	LASJ105RCC3	208-230/60/3	10.85	15	161
	Evap part #	Nominal voltage	MCA	MOP	Weight
	DFE36-53DE-E	230/60/1	12.12	20	95

