

FREEZER System

Refrigeration Specifications

LASJ250RCC4

Compressor	Air cooled Condensing Unit	Rack Size	Refrigerant
Scroll	208-230/60/1	B	R449A

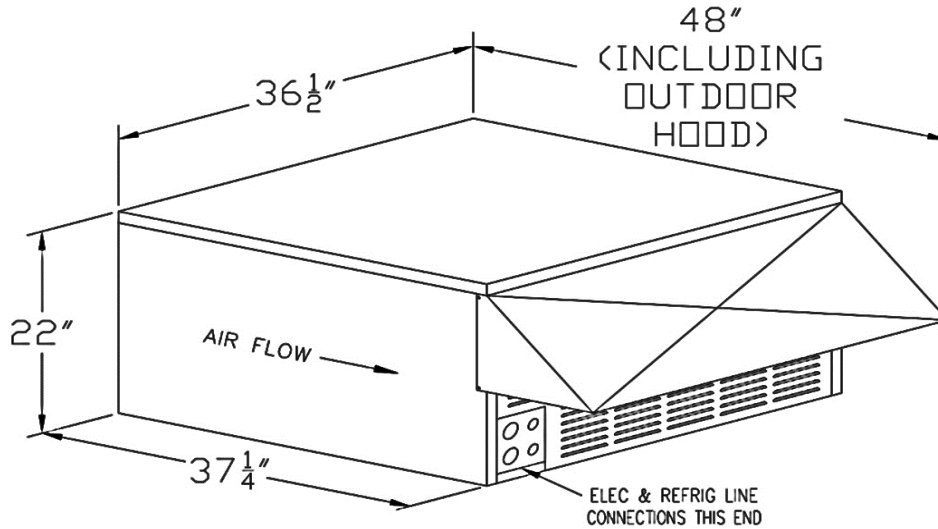

Condensing Unit MOP 40

Model #	HP	Electical Data		BTU Capacity	Connection sizes		Weight (lbs)
		MCA	MOP	Temp Setpoint -10° @ 100° Ambient	Liquid (in)	Suction (in)	
LASJ250RCC4	2 1/2	28.7	40	9,856	1/2	7/8	264

**Evaporator Unit Cooler
230/60/1**

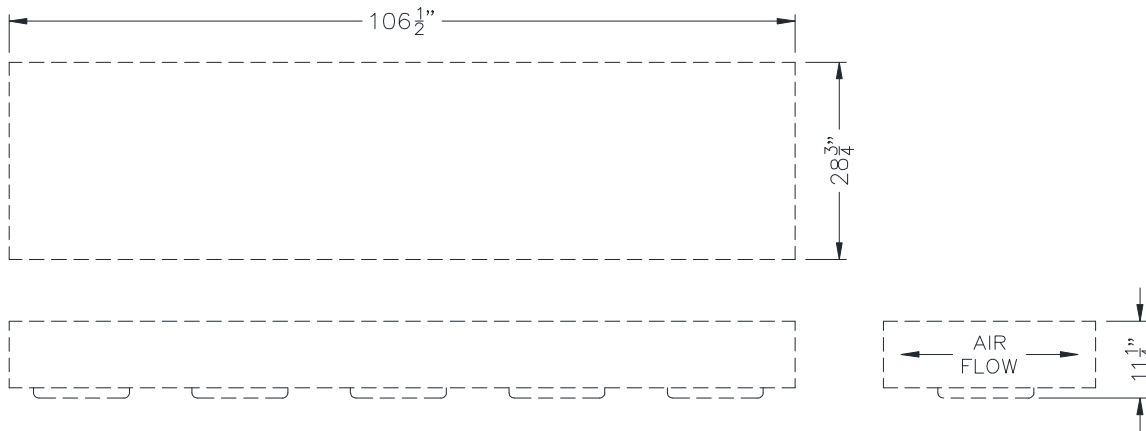

Evaporator MOP 20

Evaporator Specifications

Model #	Fan Qty	CFM	Electrical Data (1)			Connection sizes			Weight (lbs)
			MCA	MOP	Elec Defrost Amps	Liquid(in)	Suction(in)	Drain(in)	
DFE56-125DE-E	5	2440	22.7	20	17	1/2	7/8	3/4	150

Model# LASJ250RCC4	Cond part #	Nominal voltage	MCA	MOP	Weight
	LASJ250RCC4	208-230/60/1	28.7	40	264
Heat of Rejection btu/hr 0	Evap part #	Nominal voltage	MCA	MOP	Weight
	DFE56-125DE-E	230/60/1	22.7	20	150

