

FREEZER System

Refrigeration Specifications

LASJ300RCC3

Compressor	Air cooled Condensing Unit	Rack Size	Refrigerant
Scroll	208-230/60/3	B	R449A

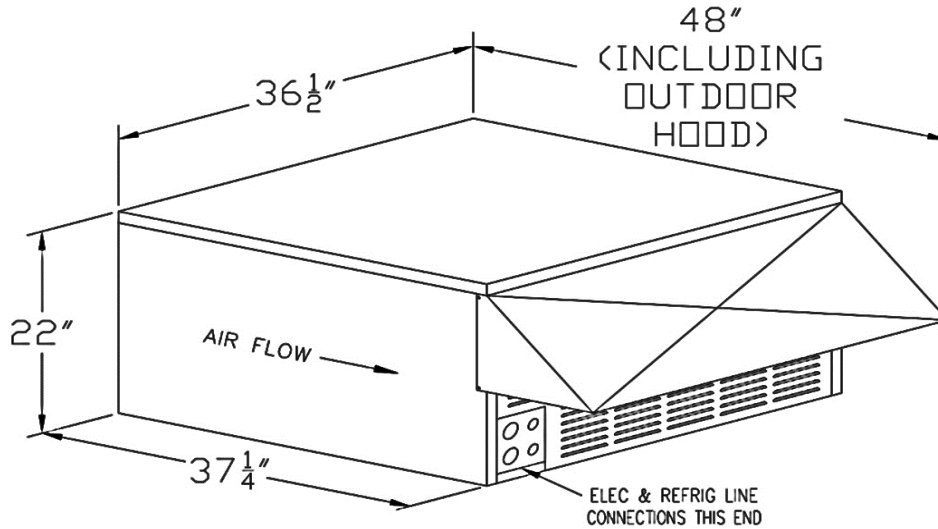

Condensing Unit MOP 35

Model #	HP	Electical Data		BTU Capacity	Connection sizes		Weight (lbs)
		MCA	MOP	Temp Setpoint -10° @ 100° Ambient	Liquid (in)	Suction (in)	
LASJ300RCC3	3	21.45	35	11,727	1/2	7/8	288

**Evaporator Unit Cooler
230/60/1**

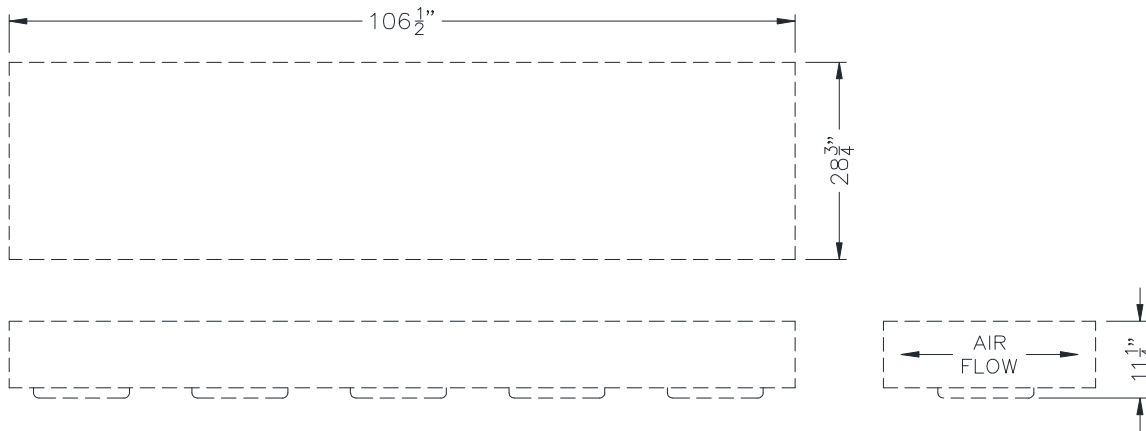

Evaporator MOP 20

Evaporator Specifications

Model #	Fan Qty	CFM	Electrical Data (1)			Connection sizes			Weight (lbs)
			MCA	MOP	Elec Defrost Amps	Liquid(in)	Suction(in)	Drain(in)	
DFE56-125DE-E	5	2440	22.7	20	17	1/2	7/8	3/4	150

Model# LASJ300RCC3	Cond part #	Nominal voltage	MCA	MOP	Weight
	LASJ300RCC3	208-230/60/3	21.45	35	288
Heat of Rejection btu/hr 0	Evap part #	Nominal voltage	MCA	MOP	Weight
	DFE56-125DE-E	230/60/1	22.7	20	150

