



NOR-LAKE, INCORPORATED
727 Second Street
Hudson, Wisconsin 54016

800-955-5253
715-386-2323
866-961-5253 Parts
800-388-5253 Service
715-386-6149 FAX
www.norlake.com

DUAL ACCESS MILK COOLERS



PROJECT:

ITEM NUMBER:

MODEL NUMBER:

SPECIFICATIONS FOR: NLMC08D, NLMC12D & NLMC16D (Suffix "W" for white exterior, "S" for stainless steel)

- **Exterior Finish:** The self-service doors are stainless steel, the remaining exterior is white enamel over smooth steel. The remaining exterior is available in stainless steel as an option.
- **Interior Finish:** The self-service doors and the remaining interior are stainless steel.
- **Insulation:** The cabinet is insulated with eco-friendly foamed-in-place polyurethane insulation.
- **Hardware:** The milk coolers are equipped with factory-installed easy roll, locking swivel casters and heavy duty floor racks. The gasketed, insulated doors with stainless steel hinges open for small child self service, close and lock. Door hold open feature secures door during serving. A drain is standard with every unit.
- **Instrumentation:** Digital thermometer measures temperature in °F.
- **Refrigeration:** Self contained R290 refrigeration system. The evaporator is a cold wall evaporator in the cabinet with no moving parts which allows more room for product. The condenser is an air cooled, copper tube and aluminum finned coil which is mounted on the base of the unit. Adjustable electronic temperature control to optimize product temperatures. Operating temperature: 34-40°F.
- **Electrical:** 115 volt, 60 Hz, 1 phase with cord and plug.
- **Performance:** Designed with a powerful refrigeration system which provides large capacity. This enables the unit to quickly pull product down to the storage temperature and maintain it.
- **Dual Access:** One unit will supply two serving lines.

STANDARD FEATURES

- Adjustable electronic temperature control
- Air-cooled condensing unit
- Cold wall evaporator
- Dual access
- Exterior stainless steel doors
- Fold back doors
- Four swivel casters, two locking
- Gasketed locking doors
- Heavy duty epoxy coated floor racks
- White exterior
- Interior stainless steel
- Key locks
- Corner bumpers
- NSF listed thermometer
- Operating temperature: 34-40°F
- Power cord and plug furnished
- ETL Safety and Sanitation listed**
- Warranties: 3 year parts and labor, 5 year compressor

OPTIONAL FEATURES*

- Stainless steel exterior (add suffix "S")

DUAL ACCESS MILK COOLERS

*Most options are available one week from receipt of order. Please contact us for specific questions.

**ETL is Underwriters Laboratories Safety Certification Mark which indicates that Intertek has tested the equipment to applicable UL and CSA Standards.

**ETL Sanitation is Underwriters Laboratories Sanitation Mark which indicates that Intertek has tested the equipment to applicable NSF Standards.

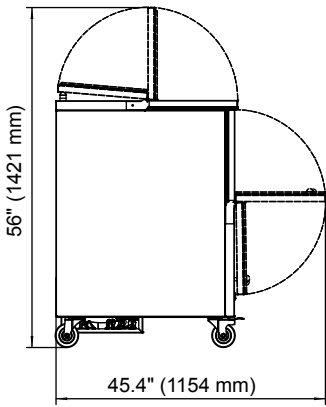

SIDE VIEW (ALL MODELS)

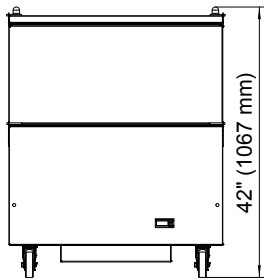

FRONT

NLMC08D

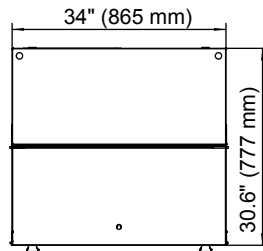

TOP

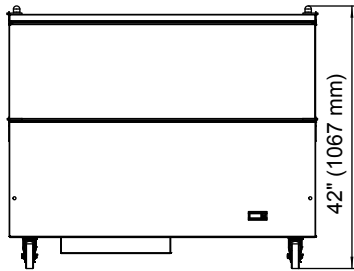

FRONT

NLMC12D

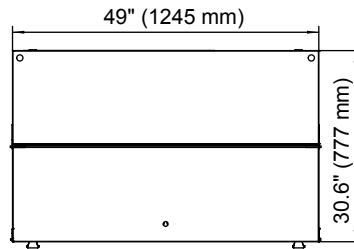

TOP

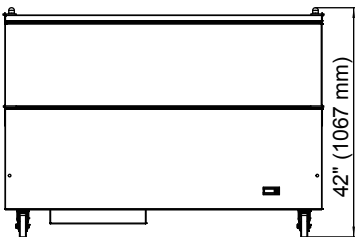

FRONT

NLMC16D

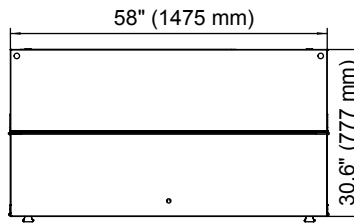

TOP

SPECIFICATIONS			
Model*	NLMC08D*	NLMC12D*	NLMC16D*
Crated Weight (lbs.) (kg)	165 (75)	212 (96)	243 (110)
Crated Height (in) (cm)	48.6 (123)	48.6 (123)	48.6 (123)
Crated Width (in) (cm)	35.8 (91)	50.8 (129)	59.8 (152)
Crated Depth (in) (cm)	32.3 (82)	32.3 (82)	32.3 (82)
Interior Height (in) (cm)	25.2 (64)	25.2 (64)	25.2 (64)
Interior Width (in) (cm)	30.9 (78)	45.9 (117)	54.9 (139)
Interior Depth (in) (cm)	26.5 (67)	26.5 (67)	26.5 (67)
Overall Height (in) (cm)	42 (107)	42 (107)	42 (107)
Overall Width (in) (cm)	34 (86)	49 (124)	58 (147)
Overall Depth (in) (cm)	30.6 (78)	30.6 (78)	30.6 (78)
Gross Cubage (CuFt) (L)	13.2 (374)	19.6 (555)	23.5 (665)
Number of Floor Racks	2	2	2
Number of Casters	4	4	4
Condensing Unit Size	1/4	1/4	1/4
Refrigerant	R290	R290	R290
Electrical Characteristics	115/60/1	115/60/1	115/60/1
Cord and Plug Furnished	Yes	Yes	Yes
Nema Plug Configuration	5-15P	5-15P	5-15P
Total Amp Draw	3.0	3.0	3.0

* Add suffix "W" for white exterior, "S" for stainless steel.

Specifications subject to change without notice.

MODEL	CASES WITH CARTONS			
	13" x 13" x 11"H		19" x 13" x 11"H	
	CASES	CARTONS	CASES	CARTONS
NLMC08D	8	352	4	288
NLMC12D	12	528	8	576
NLMC16D	16	704	10	720

MODEL	LOOSE CARTON (WITHOUT CASES)			
	FLAT TOP		PEAKED TOP (GABLE)	
	1/2 PINT	1 PINT	1/2 PINT	1 PINT
NLMC08D	864	432	680	430
NLMC12D	1368	684	1020	645
NLMC16D	1800	900	1360	860



Revision Date: 8/20
Part Number: 171225