

L1LD0043B-TE2 EVAPORATOR UNIT



Note: Pictures are for illustration only,
and may not reflect the listed model.



GENERAL					
REFRIGERANT	VOLTAGE	EVAPORATOR MODEL	DEFROST SCHEME	CONTROLLER	LISTINGS
R-448A/R-449A	208-230/60/1	WE6E037DDA	ELECTRIC	THERMOSTAT	UL/CUL

BTUH CAPACITY (At Saturated Suction Temperature (SST) with 10° TD)							
-30	-20	-10	20	25	30	35	45
4,139	4,300	4,461	-	-	-	-	-

DIMENSIONAL DATA				INSTALLATION			
OVERALL (inches)			WT (lbs)	CONNECTIONS		REFRIGERANT TYPE	
L	W	H		LIQUID	SUCTION		
32	28.375	11.25	55	3/8	7/8	R-448A/R-449A	

EVAPORATOR ELECTRICAL DATA				EXPANSION VALVE		DISTRIBUTOR NOZZLE/ORIFICE	
FAN QUANTITY	FAN AMPS	DEFROST AMPS		TXV/EEV		PART NUMBER	TYPE
		1 PHASE	3 PHASE	PART NUMBER	MODEL NUMBER		
1	0.5	3.9	N/A	09-10577	EBFDE-AA-ZP	-	L, #1/2

Bottom View

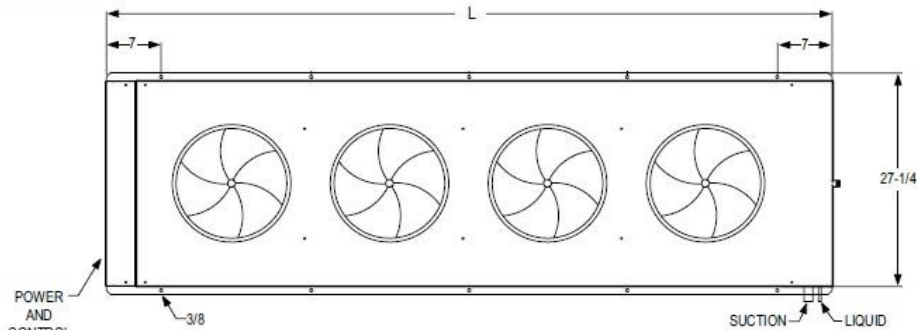

Side View

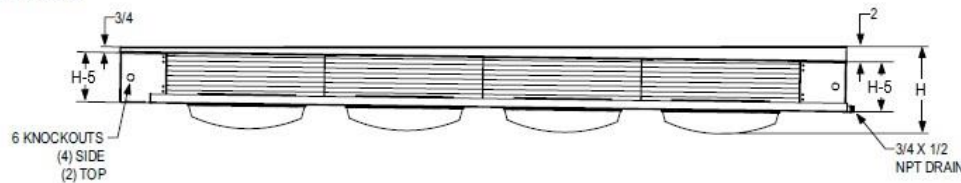

End View

