

# L1LD0209B-TE2 EVAPORATOR UNIT



Note: Pictures are for illustration only, and may not reflect the listed model.



GENERAL					
REFRIGERANT	VOLTAGE	EVAPORATOR MODEL	DEFROST SCHEME	CONTROLLER	LISTINGS
R-448A/R-449A	208-230/60/1	WE6E182DDA	ELECTRIC	THERMOSTAT	UL/CUL

BTUH CAPACITY (At Saturated Suction Temperature (SST) with 10° TD)							
-30	-20	-10	20	25	30	35	45
20,116	20,900	21,684	-	-	-	-	-

DIMENSIONAL DATA				INSTALLATION			
OVERALL (inches)			WT (lbs)	CONNECTIONS		REFRIGERANT TYPE	
L	W	H		LIQUID	SUCTION		
112	28.375	11.25	145	1/2	1 1/8	R-448A/R-449A	

EVAPORATOR ELECTRICAL DATA				EXPANSION VALVE		DISTRIBUTOR NOZZLE/ORIFICE	
FAN QUANTITY	FAN AMPS	DEFROST AMPS		TXV/EEV		PART NUMBER	TYPE
		1 PHASE	3 PHASE	PART NUMBER	MODEL NUMBER		
4	2.0	15.6	N/A	09-09152	EBFDE-C-ZP	-	L, #2-1/2

Bottom View

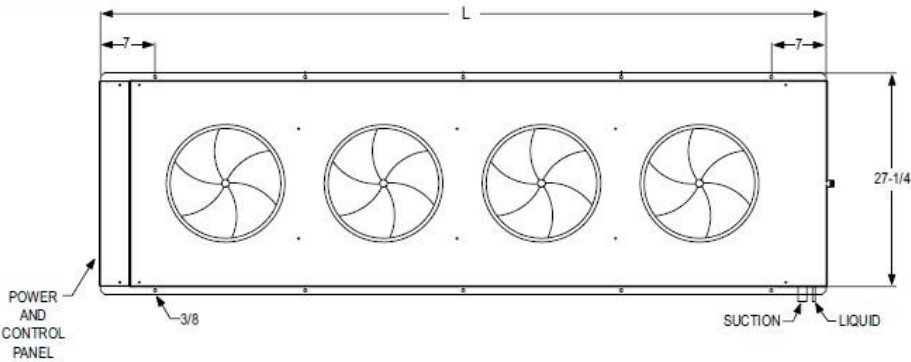

Side View

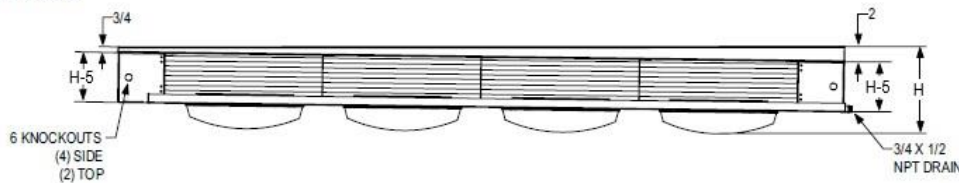

End View

