



2021 FOODSERVICE PRICE LIST

Effective November 3, 2021

Due to global supply chain issues, some models may be unavailable. Please refer to AutoQuotes for availability.

Cabinets & Merchandisers

Milk Coolers	2
AdvantEDGE™ Basemount Reach-In Refrigerators & Freezers	3
AdvantEDGE™ Sandwich/Salad Prep Tables	4
AdvantEDGE™ Pizza Prep Tables	5
AdvantEDGE™ Undercounter/Countertop Worktables	6
AdvantEDGE™ Chef Bases	7

Walk-ins & Refrigeration

Kold Locker™ Walk-ins	8-18
Kold Locker Options and Accessories	19
Shelving Kits	20
Fast-Trak® Walk-ins	21-39
Fast-Trak Options and Accessories	40
Fast-Trak Refrigeration	41-42
Fineline™ Walk-ins	43

Warranties, Terms & Conditions



Warranties	44
Terms and Conditions	46-47
Quality Policy	48

Representatives

Norlake Representatives	49
-------------------------	----

Due to global supply chain issues, some models may be unavailable. Please refer to AutoQuotes for availability.

Milk Coolers

MILK COOLERS	8	Model	List Price	HP	Voltage	Weight
 <p>NLMC12SW</p>  <p>NLMC16SS</p> <ul style="list-style-type: none"> • Eco-friendly R290 refrigerant • Cold wall evaporator refrigeration system • Corner bumpers • Heavy-duty floor racks • White exterior, stainless steel interior ("W" suffix models) • Stainless steel interior & exterior ("S" suffix models) • 3 Year parts & labor, 5 year compressor warranty • ETL Safety & Sanitation listed 		Single Access - White Exterior				
		NLMC08SW	\$4,892	1/4	115/60/1	165
		NLMC12SW	\$5,505	1/4	115/60/1	212
		NLMC16SW	\$6,116	1/4	115/60/1	243
		Single Access - Stainless Steel Exterior				
		NLMC08SS	\$5,505	1/4	115/60/1	165
		NLMC12SS	\$6,116	1/4	115/60/1	212
		NLMC16SS	\$6,728	1/4	115/60/1	243
		Dual Access - White Exterior				
		NLMC08DW	\$6,116	1/4	115/60/1	165
		NLMC12DW	\$6,728	1/4	115/60/1	212
		NLMC16DW	\$7,340	1/4	115/60/1	243
		Dual Access - Stainless Steel Exterior				
		NLMC08DS	\$6,728	1/4	115/60/1	165
		NLMC12DS	\$7,340	1/4	115/60/1	212
	NLMC16DS	\$7,953	1/4	115/60/1	243	

Due to global supply chain issues, some models may be unavailable. Please refer to AutoQuotes for availability.

AdvantEDGE™ Basemount Reach-In Refrigerators & Freezers

REFRIGERATORS	3	Model	List Price	HP	Voltage	Weight
 <ul style="list-style-type: none"> Eco-friendly R290 refrigerant 3 year parts & labor, 5 year compressor warranty UL/C-UL Safety & ETL Sanitation listed Stainless steel interior and exterior Casters Basemount refrigeration 	Full Solid Doors					
	NLR23-S	(1 Door)	\$6,652	3/8	115/60/1	313
	NLR49-S	(2 Door)	\$10,348	3/8	115/60/1	474
	NLR72-S	(3 Door)	\$14,415	3/8	115/60/1	637

NLR49-S

FREEZERS	3	Model	List Price	HP	Voltage	Weight
 <ul style="list-style-type: none"> Eco-friendly R290 refrigerant 3 year parts & labor, 5 year compressor warranty UL/C-UL Safety & ETL Sanitation listed Stainless steel interior and exterior Casters Basemount refrigeration 	Full Solid Doors					
	NLF23-S	(1 Door)	\$8,870	3/5	115/60/1	322
	NLF49-S	(2 Door)	\$13,306	3/4	115/60/1	498
	NLF72-S	(3 Door)	\$18,483	1	115/60/1	672

NLF49-S

OPTIONS	Model	List Price	Part Number
Pan Slide Rack (8 pan capacity each, 3 racks/section)	NLR23, NLF23, NLR49, NLF49, NLR72,	\$209	146515
Pan Slide Rack (15 pan capacity each, 1 rack/section)	NLR23, NLF23, NLR49, NLF49, NLR72, NLF72	\$1,812	150334
Left Hand Hinge Conversion Kit (shipped loose for field conversion)	NLR23-S, NLF23-S ONLY	\$126	146524A
Vinyl-Coated Shelf (includes 4 clips)	NLR23, NLF23	\$145	146516*
Vinyl-Coated Right or Left Door Shelf (includes 4 clips)	NLR49, NLF49	\$174	146517A
Vinyl-Coated Right or Left Door Shelf (includes 4 clips)	NLR72, NLF72	\$145	146516*
Vinyl-Coated Center Shelf (includes 4 clips)	NLR72, NLF72	\$174	146518
Additional Shelf Clips	NLR23, NLF23, NLR49, NLF49, NLR72, NLF72	\$2	146489
(4) 6" Adjustable Legs	NLR23, NLF23, NLR49, NLF49	\$211	037786
(6) 6" Adjustable Legs	NLR72, NLF72	\$283	038402

Due to global supply chain issues, some models may be unavailable. Please refer to AutoQuotes for availability.

AdvantEDGE™ Sandwich/Salad Prep Tables

STANDARD SANDWICH UNITS		3	Model	List Price	HP	Voltage	Weight
 <p>NLSP48-12</p> <ul style="list-style-type: none"> Eco-friendly R290 refrigerant 3 year parts & labor, 5 year compressor warranty UL/C-UL Safety & UL Sanitation Stainless steel tops, doors, front, sides and interior Cutting board, casters & pans standard 	NLSP27-8	8 pan capacity*	\$5,160	1/5	115/60/1	165	
	NLSP36-10	10 pan capacity*	\$6,880	1/5	115/60/1	203	
	NLSP48-12	12 pan capacity*	\$7,569	1/5	115/60/1	251	
	NLSP60-16	16 pan capacity*	\$8,258	1/5	115/60/1	278	
	NLSP72-18	18 pan capacity*	\$9,635	1/5	115/60/1	326	

MEGA TOP SANDWICH UNITS		3	Model	List Price	HP	Voltage	Weight
 <p>NLSMP27-12</p> <ul style="list-style-type: none"> Eco-friendly R290 refrigerant 3 year parts & labor, 5 year compressor warranty UL/C-UL Safety & UL Sanitation Stainless steel tops, doors, front, sides and interior Cutting board, casters & pans standard 	NLSMP27-12	12 pan capacity*	\$6,065	1/5	115/60/1	176	
	NLSMP36-15	15 pan capacity*	\$7,850	1/5	115/60/1	216	
	NLSMP48-18	18 pan capacity*	\$8,563	1/5	115/60/1	265	
	NLSMP60-24	24 pan capacity*	\$9,278	1/5	115/60/1	300	
	NLSMP72-30	30 pan capacity*	\$10,706	1/5	115/60/1	353	

* Based on 1/6 size pans

OPTIONS	Model	List Price	Part Number
Shelf (includes 4 clips)	NLSP, NLSMP 27" and (middle) 72" models	\$168	976*
Shelf (includes 4 clips)	NLSP, NLSMP 36" models	\$168	989*
Shelf (includes 4 clips)	NLSP, NLSMP 60" models	\$168	978*
Shelf (includes 4 clips)	NLSP, NLSMP 48" & (outside) 72" models	\$168	977*
10" Single Overshelf for 27" models	NLSP, NLSMP	\$697	154825
10" Single Overshelf for 36" models	NLSP, NLSMP	\$718	154848
10" Single Overshelf for 48" models	NLSP, NLSMP	\$734	154850
10" Single Overshelf for 60" models	NLSP, NLSMP	\$794	154852
10" Single Overshelf for 72" models	NLSP, NLSMP	\$813	154854
10" Double Overshelf for 27" models	NLSP, NLSMP	\$783	154826
10" Double Overshelf for 36" models	NLSP, NLSMP	\$817	154849
10" Double Overshelf for 48" models	NLSP, NLSMP	\$849	154851
10" Double Overshelf for 60" models	NLSP, NLSMP	\$1,136	154853
10" Double Overshelf for 72" models	NLSP, NLSMP	\$1,187	154855

Due to global supply chain issues, some models may be unavailable. Please refer to AutoQuotes for availability.

AdvantEDGE™ Pizza Prep Tables

PIZZA PREP TABLES	3	Model	List Price	HP	Voltage	Weight
 <ul style="list-style-type: none"> • Eco-friendly R290 refrigerant • 3 year parts & labor, 5 year compressor warranty • UL/C-UL Safety & ETL Sanitation listed • Stainless steel top, front & sides 		NLPT44 (1 Door)	\$7,384	3/8	115/60/1	304
		NLPT67 (2 Door)	\$10,916	3/8	115/60/1	397
		NLPT93 (3 Door)	\$14,610	3/8	115/60/1	489

NLPT67

OPTIONS	Model	List Price	Part Number
Shelf (includes 4 clips)	NLPT44	\$129	150343
Shelf (includes 4 clips)	NLPT67, NLPT93	\$129	150344
10" Single Overshelf	NLPT44	\$866	154835
10" Single Overshelf	NLPT67	\$1,135	154837
10" Single Overshelf	NLPT93	\$1,338	154839
10" Double Overshelf	NLPT44	\$992	154836
10" Double Overshelf	NLPT67	\$1,352	154838
10" Double Overshelf	NLPT93	\$1,635	154840

Due to global supply chain issues, some models may be unavailable. Please refer to AutoQuotes for availability.

AdvantEDGE™ Undercounter/Countertop Worktables

REFRIGERATORS	3	Model	List Price	HP	Voltage	Weight
 <ul style="list-style-type: none"> Eco-friendly R290 refrigerant 3 year parts & labor, 5 year compressor warranty UL/C-UL Safety & UL Sanitation listed Stainless steel top, front & sides 		NLUR27	\$4,638	1/5	115/60/1	143
		NLUR36	\$6,065	1/5	115/60/1	181
		NLUR48	\$6,779	1/5	115/60/1	227
		NLUR60	\$7,493	1/5	115/60/1	254
		NLUR72	\$8,207	1/5	115/60/1	295

NLUR48

FREEZERS	3	Model	List Price	HP	Voltage	Weight
 <ul style="list-style-type: none"> Eco-friendly R290 refrigerant 3 year parts & labor, 5 year compressor warranty UL/C-UL Safety & UL Sanitation listed Stainless steel top, front & sides 		NLUF27	\$5,351	1/5	115/60/1	152
		NLUF48	\$7,135	1/2	115/60/1	238
		NLUF60	\$8,920	1/2	115/60/1	276

NLUF27

OPTIONS	Model	List Price	Part Number
Shelf (includes 4 clips)	NLUR27 and NLUR72 (center)	\$168	976*
Shelf (includes 4 clips)	NLUR36 model	\$168	989*
Shelf (includes 4 clips)	NLUR60 model	\$168	978*
Shelf (includes 4 clips)	NLUR48 & (outside) NLUR72 models	\$168	977*
Shelf (includes 4 clips)	NLUF27 model	\$168	171483
Shelf (includes 4 clips)	NLUF48 model	\$168	171484
Shelf (includes 4 clips)	NLUF60 model	\$168	171485
3" Low Profile Caster Kit (for ADA compliance)	NLUR, NLUF	\$198	145826A
4" Caster Kit	NLUR, NLUF	\$198	136043A
6" Leg Kit (to replace standard casters)	NLUR, NLUF	\$117	037786
10" Single Overshelf for 27" models	NLUR, NLUF	\$697	154825
10" Single Overshelf for 36" models	NLUR	\$718	154848
10" Single Overshelf for 48" models	NLUR, NLUF	\$734	154850
10" Single Overshelf for 60" models	NLUR, NLUF	\$794	154852
10" Single Overshelf for 72" models	NLUR	\$813	154854
10" Double Overshelf for 27" models	NLUR, NLUF	\$783	154826
10" Double Overshelf for 36" models	NLUR	\$817	154849
10" Double Overshelf for 48" models	NLUR, NLUF	\$892	154851
10" Double Overshelf for 60" models	NLUR, NLUF	\$1,136	154853
10" Double Overshelf for 72" models	NLUR	\$1,186	154855

Due to global supply chain issues, some models may be unavailable. Please refer to AutoQuotes for availability.

AdvantEDGE™ Chef Bases

REFRIGERATED CHEF BASES	3	Model	List Price	HP	Voltage	Weight
 <p>NLCB72</p> <ul style="list-style-type: none"> Eco-friendly R290 refrigerant 3 year parts & labor, 5 year compressor warranty Stainless steel interior, exterior & drawers Curved handle with recessed pocket UL/C-UL safety & ETL Sanitation listed 		NLCB36	\$9,440	1/5	115/60/1	220
		NLCB48	\$10,512	1/5	115/60/1	220
		NLCB53	\$10,765	1/5	115/60/1	231
		NLCB60	\$11,695	1/5	115/60/1	243
		NLCB72	\$13,381	1/5	115/60/1	309
		NLCB84	\$14,118	3/8	115/60/1	348
		NLCB96	\$16,290	3/8	115/60/1	384

OPTIONS	Model	List Price	Part Number
Horizontal Dividers/Pan Supports, 20.5" x .87"	All models	\$80	149830
Horizontal Dividers/Pan Supports, 12" x .88"	All models	\$80	149831
4" Depth Stainless Steel Pans (Full Size)	All models	\$114	101681
Plate Style Legs	All models	\$211	037786



Single Room Coolers Or Freezers

ORDERING IS EASY!

Simply follow the six (6) easy steps outlined below and your standard single room cooler or freezer will be shipped the **SAME DAY!**

STEP 1 - Unit Location

“KL” Indoor Kold Locker™

“KOD” Outdoor Kold Locker™

STEP 2 - Design Temperature

“ ” Blank if no refrigeration is required

“B” +38°F to +35°F Cooler

“F” -10°F Freezer

Consult Factory -20°F Extra-Low

STEP 3 - Overall Height Required

“ ” Blank if 6'- 7"

“74” 7'-4" floorless (cooler only)

“77” 7'-7" with floor

Series 46 available 6'-7" high, with floor only

STEP 4 - Size and Shape

Choose from one of the floor plan layouts on the following page. Proper numbers are shown in center of the floor plan.

STEP 5 - Refrigeration System

“C” Ceiling Mount

“W” Wall Mount

STEP 6 - Door Swing

“R” Right Hand

“L” Left Hand

Floor Plans Single Room Coolers Or Freezers

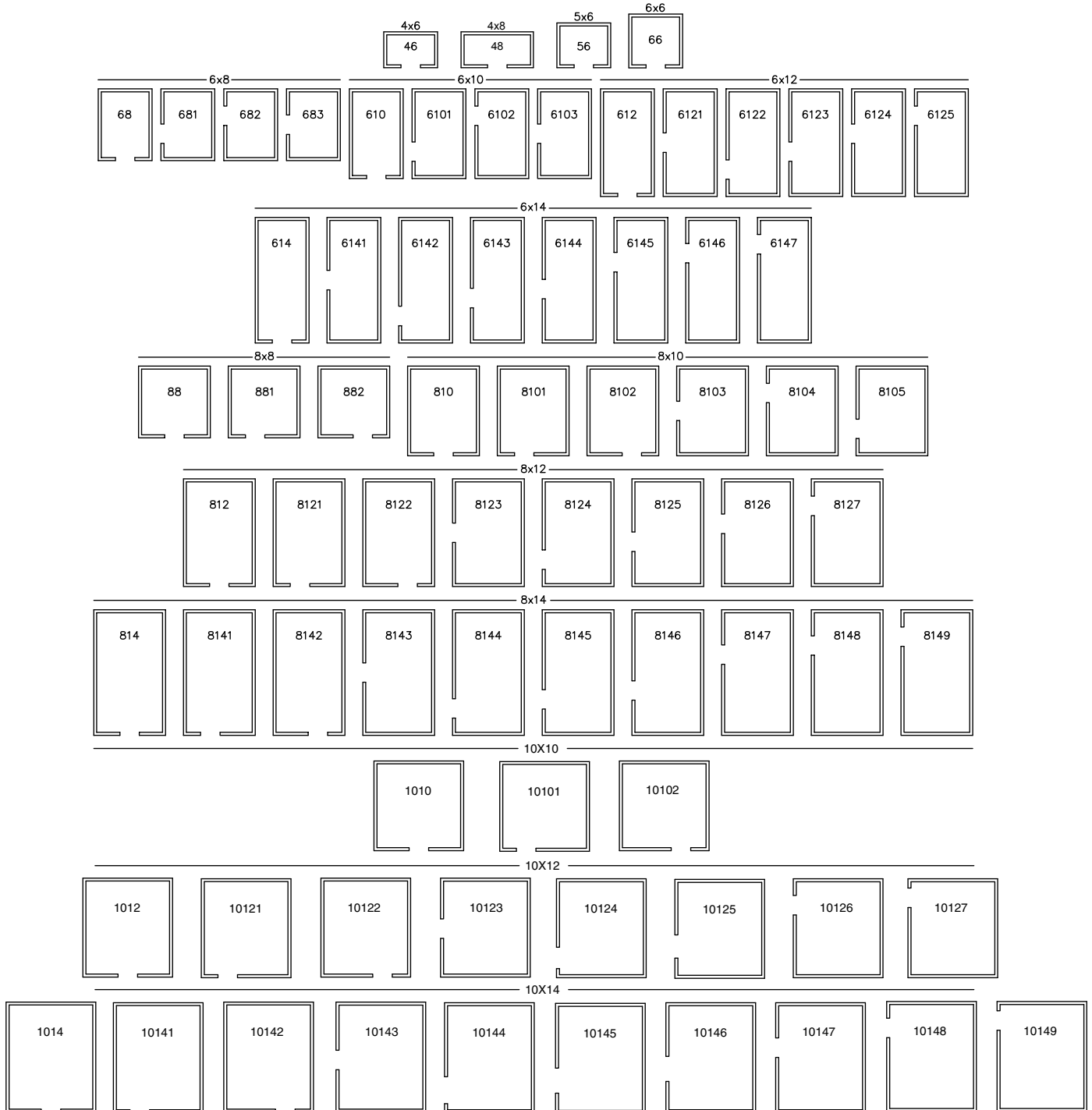



KOLD LOCKER™ WALK-INS

INDOOR UTILITY COOLERS AND FREEZERS CEILING MOUNT CAPSULE PAK™ REFRIGERATION

6'- 7" HIGH, WITH FLOOR MODELS
WITH 4" HFC free HFO POLYURETHANE INSULATED PANELS

Model Number	Kold Locker™ List Total Panels Only	Kold Locker™ Total Ship Wt.	Cooler Remote Refrigeration (Normal Use)	Cooler Remote Refrigeration (Heavy Use)	Freezer Remote Refrigeration (Normal Use)	Freezer Remote Refrigeration (Heavy Use)
BLANK Kold Locker™ (NO CEILING CUTOUT)						
KL66-X	\$12,897	742	MHMD005AB E1MD0060A-TA2	MHMD007AB E1MD0078A-TA2	NA	MSLD015AB E1LD0056B-TE2
KL68-X	\$14,860	901	MHMD005AB E1MD0060A-TA2	MHMD007AB E1MD0078A-TA2	NA	MSLD015AB E1LD0056B-TE2
KL610-X	\$16,842	1060	MHMD007AB E1MD0078A-TA2	MHMD007AB E1MD0078A-TA2	MSLD015AB E1LD0056B-TE2	MSLD025AB E1LD0106B-TE2
KL612-X	\$18,805	1219	MHMD007AB E1MD0078A-TA2	MHMD010AB E1MD0085A-TA2	MSLD020AB E1LD0088B-TE2	MSLD025AB E1LD0106B-TE2
KL614-X	\$20,788	1377	MHMD007AB E1MD0078A-TA2	MHMD010AB E1MD0085A-TA2	MSLD020AB E1LD0088B-TE2	MSLD025AB E1LD0106B-TE2
KL88-X	\$17,219	1088	MHMD005AB E1MD0060A-TA2	MHMD007AB E1MD0078A-TA2	MSLD015AB E1LD0056B-TE2	MSLD025AB E1LD0106B-TE2
KL810-X	\$19,420	1274	MHMD007AB E1MD0078A-TA2	MHMD007AB E1MD0078A-TA2	MSLD015AB E1LD0056B-TE2	MSLD025AB E1LD0106B-TE2
KL812-X	\$21,583	1461	MHMD007AB E1MD0078A-TA2	MHMD010AB E1MD0085A-TA2	MSLD025AB E1LD0106B-TE2	MSLD025AB E1LD0106B-TE2
KL814-X	\$23,861	1647	MHMD007AB E1MD0078A-TA2	MHMD010AB E1MD0085A-TA2	MSLD025AB E1LD0106B-TE2	MSLD030AB E1LD0106B-TE2

X=R for Right Hand Door or L for Left Hand Door

Model Number	Kold Locker™ List Total Panels & Refrig	Kold Locker™ Total Ship Wt.	Kold Locker™ Panels Only List	Refrigeration Series	Refrigeration System Only List	Refrigeration Voltage 60/Hz
+35° F COOLER WITH CEILING MOUNT CAPSULE PAK™ REFRIGERATION						
KLB66-Cx	\$21,300	915	\$13,024	CPB050JC-S-0-EV	\$8,276	208-230
KLB68-Cx	\$23,226	1089	\$14,950	CPB050JC-S-0-EV	\$8,276	208-230
KLB610-Cx	\$26,369	1248	\$16,895	CPB075JC-S-4-EV	\$9,474	208-230
KLB612-Cx	\$28,304	1542	\$18,830	CPB075JC-S-4-EV	\$9,474	208-230
KLB614-Cx	\$30,361	1796	\$20,887	CPB075JC-S-4-EV	\$9,474	208-230
KLB88-Cx	\$26,769	1276	\$17,295	CPB075JC-S-4-EV	\$9,474	208-230
KLB810-Cx	\$28,952	1597	\$19,478	CPB075JC-S-4-EV	\$9,474	208-230
KLB812-Cx	\$31,140	1880	\$21,666	CPB075JC-S-4-EV	\$9,474	208-230
KLB814-Cx	\$33,376	2066	\$23,902	CPB075JC-S-4-EV	\$9,474	208-230
-10° F FREEZER WITH CEILING MOUNT CAPSULE PAK™ REFRIGERATION						
KLF66-Cx	\$24,248	1076	\$13,288	CPF075JC-S-4-EV	\$10,960	208-230
KLF68-Cx	\$26,873	1254	\$15,324	CPF100JC-S-4-EV	\$11,549	208-230
KLF610-Cx	\$28,856	1491	\$17,307	CPF100JC-S-4-EV	\$11,549	208-230
KLF612-Cx	\$31,880	1668	\$19,270	CPF150JC-S-4-EV	\$12,610	208-230
KLF614-Cx	\$35,466	1845	\$21,232	CPF200JC-S-4-EV	\$14,234	20-230
KLF88-Cx	\$30,289	1519	\$17,679	CPF150JC-S-4-EV	\$12,610	208-230
KLF810-Cx	\$32,490	1723	\$19,880	CPF150JC-S-4-EV	\$12,610	208-230
KLF812-Cx	\$34,697	1910	\$22,087	CPF150JC-S-4-EV	\$12,610	208-230
KLF814-Cx	\$38,600	2096	\$24,366	CPF200JC-S-4-EV	\$14,234	208-230

X=R for Right Hand Door or L for Left Hand Door

- Export crating available as an option. Consult factory for pricing.
- **OPTIONAL REMOTE CAPSULE PAK™ Refrigeration Systems:** Include ambient controls, weather-proof hoods, pre-charged systems with quick connects for simple field connections to pre-charged lines of your choice. Consult factory for application, pricing and ship date availability.
- **SHELVING:** See p. 20 for pricing and shipping weights. Nor-Lake shelving utilizes a support clip to eliminate center posts to maximize usable square footage.
- **WARRANTY INFORMATION:** See p. 44



KOLD LOCKER™ WALK-INS

INDOOR UTILITY COOLERS AND FREEZERS CEILING MOUNT CAPSULE PAK™ REFRIGERATION

7'- 4" HIGH, FLOORLESS MODELS
WITH 4" HFC free HFO POLYURETHANE INSULATED PANELS

Model Number	Kold Locker™ List Total Panels & Refrig	Kold Locker™ Total Ship Wt.	Kold Locker™ Panels Only List	Refrigeration Series	Refrigeration System Only List	Refrigeration Voltage 60/Hz
+35° F COOLER WITH CEILING MOUNT CAPSULE PAK™ REFRIGERATION						
KLB7466-Cx	\$20,209	884	\$11,933	CPB050JC-S-0-EV	\$8,276	208-230
KLB7468-Cx	\$21,836	1148	\$13,560	CPB050JC-S-0-EV	\$8,276	208-230
KLB74610-Cx	\$24,222	1276	\$14,748	CPB075JC-S-4-EV	\$9,474	208-230
KLB74612-Cx	\$25,857	1393	\$16,383	CPB075JC-S-4-EV	\$9,474	208-230
KLB74614-Cx	\$27,155	1628	\$17,681	CPB075JC-S-4-EV	\$9,474	208-230
KLB7488-Cx	\$24,992	1277	\$15,518	CPB075JC-S-4-EV	\$9,474	208-230
KLB74810-Cx	\$26,250	1418	\$16,776	CPB075JC-S-4-EV	\$9,474	208-230
KLB74812-Cx	\$28,018	1666	\$18,544	CPB075JC-S-4-EV	\$9,474	208-230
KLB74814-Cx	\$29,911	1807	\$19,803	CPB100JC-S-4-EV	\$10,108	208-230
X=R for Right Hand Door or L for Left Hand Door						

INDOOR UTILITY COOLERS AND FREEZERS CEILING MOUNT CAPSULE PAK™ REFRIGERATION

7'- 7" HIGH, WITH FLOOR MODELS
WITH 4" HFC free HFO POLYURETHANE INSULATED PANELS

Model Number	Kold Locker™ List Total Panels & Refrig	Kold Locker™ Total Ship Wt.	Kold Locker™ Panels Only List	Refrigeration Series	Refrigeration System Only List	Refrigeration Voltage 60/Hz
+35° F COOLER WITH CEILING MOUNT CAPSULE PAK™ REFRIGERATION						
KLB7766-Cx	\$21,692	991	\$13,416	CPB050JC-S-0-EV	\$8,276	208-230
KLB7768-Cx	\$23,683	1177	\$15,407	CPB050JC-S-0-EV	\$8,276	208-230
KLB77610-Cx	\$26,897	1483	\$17,423	CPB075JC-S-4-EV	\$9,474	208-230
KLB77612-Cx	\$28,888	1655	\$19,414	CPB075JC-S-4-EV	\$9,474	208-230
KLB77614-Cx	\$31,004	1922	\$21,530	CPB075JC-S-4-EV	\$9,474	208-230
KLB7788-Cx	\$27,323	1511	\$17,849	CPB075JC-S-4-EV	\$9,474	208-230
KLB77810-Cx	\$29,543	1710	\$20,069	CPB075JC-S-4-EV	\$9,474	208-230
KLB77812-Cx	\$31,797	2005	\$22,323	CPB075JC-S-4-EV	\$9,474	208-230
KLB77814-Cx	\$34,726	2205	\$24,618	CPB100JC-S-4-EV	\$10,108	208-230
-10° F FREEZER WITH CEILING MOUNT CAPSULE PAK™ REFRIGERATION						
KLF7766-Cx	\$25,310	1252	\$13,761	CPF100JC-S-4-EV	\$11,549	208-230
KLF7768-Cx	\$27,340	1420	\$15,791	CPF100JC-S-4-EV	\$11,549	208-230
KLF77610-Cx	\$30,445	1609	\$17,835	CPF150JC-S-4-EV	\$12,610	208-230
KLF77612-Cx	\$32,474	1781	\$19,864	CPF150JC-S-4-EV	\$12,610	208-230
KLF7788-Cx	\$30,830	1637	\$18,220	CPF150JC-S-4-EV	\$12,610	208-230
KLF77810-Cx	\$33,092	1836	\$20,482	CPF150JC-S-4-EV	\$12,610	208-230
KLF77812-Cx	\$35,366	1902	\$22,756	CPF150JC-S-4-EV	\$12,610	208-230
KLF77814-Cx	\$39,330	1990	\$25,096	CPF200JC-S-4-EV	\$14,234	208-230
X=R for Right Hand Door or L for Left Hand Door						

- **Export crating available as an option. Consult factory for pricing.**
- **OPTIONAL REMOTE CAPSULE PAK™ Refrigeration Systems:** Include ambient controls, weather-proof hoods, pre-charged systems with quick connects for simple field connections to pre-charged lines of your choice. Consult factory for application, pricing and ship date availability.
- **SHELVING:** See p. 20 for pricing and shipping weights. Nor-Lake shelving utilizes a support clip to eliminate center posts to maximize usable square footage.
- **WARRANTY INFORMATION:** See p. 44



KOLD LOCKER™ WALK-INS

INDOOR UTILITY COOLERS AND FREEZERS CEILING MOUNT CAPSULE PAK™ REFRIGERATION

8' - 7" HIGH, WITH FLOOR MODELS
WITH 4" HFC free HFO POLYURETHANE INSULATED PANELS

Model Number	Kold Locker™ List Total Panels & Refrig	Kold Locker™ Total Ship Wt.	Kold Locker™ Panels Only List	Refrigeration Series	Refrigeration System Only List	Refrigeration Voltage 60/Hz
+35° F COOLER WITH CEILING MOUNT CAPSULE PAK™ REFRIGERATION						
KLB8766-Cx	\$22,060	1181	\$13,784	CPB050JC-S-0-EV	\$8,276	208-230
KLB8768-Cx	\$24,128	1360	\$15,852	CPB050JC-S-0-EV	\$8,276	208-230
KLB87610-Cx	\$27,401	1610	\$17,927	CPB075JC-S-4-EV	\$9,474	208-230
KLB87612-Cx	\$29,469	1796	\$19,995	CPB075JC-S-4-EV	\$9,474	208-230
KLB87614-Cx	\$31,646	2090	\$22,172	CPB075JC-S-4-EV	\$9,474	208-230
KLB8788-Cx	\$27,852	1638	\$18,378	CPB075JC-S-4-EV	\$9,474	208-230
KLB87810-Cx	\$30,132	1850	\$20,658	CPB075JC-S-4-EV	\$9,474	208-230
KLB87812-Cx	\$33,053	2040	\$22,945	CPB100JC-S-4-EV	\$10,108	208-230
KLB87814-Cx	\$35,376	2389	\$25,268	CPB100JC-S-4-EV	\$10,108	208-230
-10° F FREEZER WITH CEILING MOUNT CAPSULE PAK™ REFRIGERATION						
KLF8766-Cx	\$25,685	1322	\$14,136	CPF100JC-S-4-EV	\$11,549	208-230
KLF8768-Cx	\$27,793	1501	\$16,244	CPF100JC-S-4-EV	\$11,549	208-230
KLF87610-Cx	\$30,959	1736	\$18,349	CPF150JC-S-4-EV	\$12,610	208-230
KLF87612-Cx	\$33,067	1922	\$20,457	CPF150JC-S-4-EV	\$12,610	208-230
KLF87614-Cx	\$36,909	2108	\$22,675	CPF200JC-S-4-EV	\$14,234	208-230
KLF8788-Cx	\$31,369	1764	\$18,759	CPF150JC-S-4-EV	\$12,610	208-230
KLF87810-Cx	\$33,693	1976	\$21,083	CPF150JC-S-4-EV	\$12,610	208-230
KLF84812-Cx	\$37,698	2040	\$23,464	CPF200JC-S-4-EV	\$14,234	208-230
KLF87814-Cx	\$40,066	2389	\$25,832	CPF200JC-S-4-EV	\$14,234	208-230

X=R for Right Hand Door or L for Left Hand Door

- **Export crating available as an option. Consult factory for pricing.**
- **OPTIONAL REMOTE CAPSULE PAK™ Refrigeration Systems:** Include ambient controls, weather-proof hoods, pre-charged systems with quick connects for simple field connections to pre-charged lines of your choice. Consult factory for application, pricing and ship date availability.
- **SHELVING:** See p. 20 for pricing and shipping weights. Nor-Lake shelving utilizes a support clip to eliminate center posts to maximize usable square footage.
- **WARRANTY INFORMATION:** See p. 44



KOLD LOCKER™ WALK-INS

OUTDOOR UTILITY COOLERS AND FREEZERS CEILING MOUNT CAPSULE PAK™ REFRIGERATION

6'- 7" HIGH, WITH FLOOR MODELS
WITH 4" HFC free HFO POLYURETHANE INSULATED PANELS

Model Number	Kold Locker™ List Total Panels & Refrig	Kold Locker™ Total Ship Wt.	Kold Locker™ Panels Only List	Refrigeration Series	Refrigeration System Only List	Refrigeration Voltage 60/Hz
+35° F COOLER WITH CEILING MOUNT CAPSULE PAK™ REFRIGERATION						
KODB66-Cx	\$22,520	1127	\$13,556	CPB050JC-E-0-EV	\$8,964	208-230
KODB68-Cx	\$24,541	1290	\$15,577	CPB050JC-E-0-EV	\$8,964	208-230
KODB610-Cx	\$27,687	1455	\$17,652	CPB075JC-E-4-EV	\$10,035	208-230
KODB612-Cx	\$29,696	1620	\$19,661	CPB075JC-E-4-EV	\$10,035	208-230
KODB614-Cx	\$32,380	1889	\$21,847	CPB100JC-E-4-EV	\$10,533	208-230
KODB88-Cx	\$28,077	1485	\$18,042	CPB075JC-E-4-EV	\$10,035	208-230
KODB810-Cx	\$30,391	1679	\$20,356	CPB075JC-E-4-EV	\$10,035	208-230
KODB812-Cx	\$33,185	1974	\$22,652	CPB100JC-E-4-EV	\$10,533	208-230
KODB814-Cx	\$35,602	2173	\$25,069	CPB100JC-E-4-EV	\$10,533	208-230
-10° F FREEZER WITH CEILING MOUNT CAPSULE PAK™ REFRIGERATION						
KODF66-Cx	\$26,039	1212	\$13,903	CPF075JC-E-4-EV	\$12,136	208-230
KODF68-Cx	\$28,293	1377	\$15,953	CPF100JC-E-4-EV	\$12,340	208-230
KODF610-Cx	\$30,408	1629	\$18,068	CPF100JC-E-4-EV	\$12,340	208-230
KODF612-Cx	\$33,796	1794	\$20,117	CPF150JC-E-4-EV	\$13,679	208-230
KODF614-Cx	\$37,244	1889	\$22,343	CPF200JC-E-4-EV	\$14,901	208-230
KODF88-Cx	\$30,756	1659	\$18,416	CPF100JC-E-4-EV	\$12,340	208-230
KODF810-Cx	\$33,115	1853	\$20,775	CPF100JC-E-4-EV	\$12,340	208-230
KODF812-Cx	\$36,771	2047	\$23,092	CPF150JC-E-4-EV	\$13,679	208-230
KODF814-Cx	\$40,457	2241	\$25,556	CPF200JC-E-4-EV	\$14,901	208-230

X=R for Right Hand Door or L for Left Hand Door

OUTDOOR UTILITY COOLERS AND FREEZERS CEILING MOUNT CAPSULE PAK™ REFRIGERATION

7'- 7" HIGH, WITH FLOOR MODELS
WITH 4" HFC free HFO POLYURETHANE INSULATED PANELS

Model Number	Kold Locker™ List Total Panels & Refrig	Kold Locker™ Total Ship Wt.	Kold Locker™ Panels Only List	Refrigeration Series	Refrigeration System Only List	Refrigeration Voltage 60/Hz
+35° F COOLER WITH CEILING MOUNT CAPSULE PAK™ REFRIGERATION						
KODB7766-Cx	\$22,922	1201	\$13,958	CPB050JC-E-0-EV	\$8,964	208-230
KODB7768-Cx	\$24,999	1378	\$16,035	CPB050JC-E-0-EV	\$8,964	208-230
KODB77610-Cx	\$28,205	1555	\$18,170	CPB075JC-E-4-EV	\$10,035	208-230
KODB77612-Cx	\$30,778	1735	\$20,245	CPB100JC-E-4-EV	\$10,533	208-230
KODB77614-Cx	\$33,024	2015	\$22,491	CPB100JC-E-4-EV	\$10,533	208-230
KODB7788-Cx	\$28,608	1587	\$18,573	CPB075JC-E-4-EV	\$10,035	208-230
KODB77810-Cx	\$30,981	1794	\$20,946	CPB075JC-E-4-EV	\$10,035	208-230
KODB77812-Cx	\$33,841	2104	\$23,308	CPB100JC-E-4-EV	\$10,533	208-230
KODB77814-Cx	\$36,243	2312	\$25,710	CPB100JC-E-4-EV	\$10,533	208-230
-10° F FREEZER WITH CEILING MOUNT CAPSULE PAK™ REFRIGERATION						
KODF7766-Cx	\$26,439	1288	\$14,303	CPF075JC-E-4-EV	\$12,136	208-230
KODF7768-Cx	\$28,759	1552	\$16,419	CPF100JC-E-4-EV	\$12,340	208-230
KODF77610-Cx	\$30,936	1729	\$18,596	CPF100JC-E-4-EV	\$12,340	208-230
KODF77612-Cx	\$34,390	1907	\$20,711	CPF150JC-E-4-EV	\$13,679	208-230
KODF77614-Cx	\$37,902	2015	\$23,001	CPF200JC-E-4-EV	\$14,901	208-230
KODF7788-Cx	\$32,636	1759	\$18,957	CPF150JC-E-4-EV	\$13,679	208-230
KODF77810-Cx	\$35,056	1887	\$21,377	CPF150JC-E-4-EV	\$13,679	208-230
KODF77812-Cx	\$38,662	2015	\$23,761	CPF200JC-E-4-EV	\$14,901	208-230
KODF77814-Cx	\$41,110	2209	\$26,209	CPF200JC-E-4-EV	\$14,901	208-230

X=R for Right Hand Door or L for Left Hand Door

- **Export crating available as an option. Consult factory for pricing.**
- **OPTIONAL REMOTE CAPSULE PAK™ Refrigeration Systems:** Include ambient controls, weather-proof hoods, pre-charged systems with quick connects for simple field connections to pre-charged lines of your choice. Consult factory for application, pricing and ship date availability.
- **SHELVING:** See p. 20 for pricing and shipping weights. Nor-Lake shelving utilizes a support clip to eliminate center posts to maximize usable square footage.
- **WARRANTY INFORMATION:** See p. 44



KOLD LOCKER™ WALK-INS

OUTDOOR UTILITY COOLERS AND FREEZERS CEILING MOUNT CAPSULE PAK™ REFRIGERATION

8'- 7" HIGH, WITH FLOOR MODELS
WITH 4" HFC free HFO POLYURETHANE INSULATED PANELS

Model Number	Kold Locker™ List Total Panels & Refrig	Kold Locker™ Total Ship Wt.	Kold Locker™ Panels Only List	Refrigeration Series	Refrigeration System Only List	Refrigeration Voltage 60/Hz
+35° F COOLER WITH CEILING MOUNT CAPSULE PAK™ REFRIGERATION						
KODB8766-Cx	\$23,290	1301	\$14,326	CPB050JC-E-0-EV	\$8,964	208-230
KODB8768-Cx	\$25,443	1490	\$16,479	CPB050JC-E-0-EV	\$8,964	208-230
KODB87610-Cx	\$28,709	1683	\$18,674	CPB075JC-E-4-EV	\$10,035	208-230
KODB87612-Cx	\$31,359	1879	\$20,826	CPB100JC-E-4-EV	\$10,533	208-230
KODB87614-Cx	\$33,665	2175	\$23,132	CPB100JC-E-4-EV	\$10,533	208-230
KODB8788-Cx	\$29,137	1715	\$19,102	CPB075JC-E-4-EV	\$10,035	208-230
KODB87810-Cx	\$32,069	1938	\$21,536	CPB100JC-E-4-EV	\$10,533	208-230
KODB87812-Cx	\$34,463	2264	\$23,930	CPB100JC-E-4-EV	\$10,533	208-230
KODB87814-Cx	\$36,969	2488	\$26,436	CPB100JC-E-4-EV	\$10,533	208-230
-10° F FREEZER WITH CEILING MOUNT CAPSULE PAK™ REFRIGERATION						
KODF8766-Cx	\$27,018	1384	\$14,678	CPF100JC-E-4-EV	\$12,340	208-230
KODF8768-Cx	\$29,212	1664	\$16,872	CPF100JC-E-4-EV	\$12,340	208-230
KODF87610-Cx	\$32,789	1857	\$19,110	CPF150JC-E-4-EV	\$13,679	208-230
KODF87612-Cx	\$34,921	2051	\$21,242	CPF150JC-E-4-EV	\$13,679	208-230
KODF87614-Cx	\$38,554	2175	\$23,653	CPF200JC-E-4-EV	\$14,901	208-230
KODF8788-Cx	\$33,176	1887	\$19,497	CPF150JC-E-4-EV	\$13,679	208-230
KODF87810-Cx	\$35,657	2031	\$21,978	CPF150JC-E-4-EV	\$13,679	208-230
KODF87812-Cx	\$39,369	2264	\$24,468	CPF200JC-E-4-EV	\$14,901	208-230
KODF87814-Cx	\$41,924	2488	\$27,023	CPF200JC-E-4-EV	\$14,901	208-230
<i>X=R for Right Hand Door or L for Left Hand Door</i>						

- **Export crating available as an option. Consult factory for pricing.**
- **OPTIONAL REMOTE CAPSULE PAK™ Refrigeration Systems:** Include ambient controls, weather-proof hoods, pre-charged systems with quick connects for simple field connections to pre-charged lines of your choice. Consult factory for application, pricing and ship date availability.
- **SHELVING:** See p. 20 for pricing and shipping weights. Nor-Lake shelving utilizes a support clip to eliminate center posts to maximize usable square footage.
- **WARRANTY INFORMATION:** See p. 44



KOLD LOCKER™ WALK-INS

INDOOR UTILITY COOLERS AND FREEZERS CEILING MOUNT CAPSULE PAK™ REFRIGERATION

6'- 7" HIGH, WITH FLOOR MODELS
WITH 4" HFC free HFO POLYURETHANE INSULATED PANELS

Model Number	Kold Locker™ List Total Panels Only	Kold Locker™ Total Ship Wt.	Cooler Remote Refrigeration (Normal Use)	Cooler Remote Refrigeration (Heavy Use)	Freezer Remote Refrigeration (Normal Use)	Freezer Remote Refrigeration (Heavy Use)
BLANK Kold Locker™ (NO CEILING CUTOUT)						
KL46-X	\$10,375	575	NA	NA	NA	NA
KL56-X	\$18,263	658	NA	NA	NA	NA
KL1010-X	\$22,478	1488	MHMD007AB E1MD0078A-TA2	MHMD010AB E1MD0085A-TA2	MSLD025AB E1LD0106B-TE2	LAS200
KL1012-X	\$24,822	1703	MHMD007AB E1MD0078A-TA2	MHMD010AB E1MD0085A-TA2	MSLD025AB E1LD0106B-TE2	MSLD030AB E1LD0106B-TE2
KL1014-X	\$27,877	1917	MHMD007AB E1MD0078A-TA2	MHMD010AB E1MD0085A-TA2	MSLD025AB E1LD0106B-TE2	MSLD030AB E1LD0106B-TE2
<i>X=R for Right Hand Door or L for Left Hand Door</i>						

Model Number	Kold Locker™ List Total Panels & Refrig	Kold Locker™ Total Ship Wt.	Kold Locker™ Panels Only List	Refrigeration Series	Refrigeration System Only List	Refrigeration Voltage 60/Hz
+35° F COOLER WITH CEILING MOUNT CAPSULE PAK™ REFRIGERATION						
KLB46-Cx	\$19,930	748	\$11,654	CPB050JC-S-0-EV	\$8,276	120
KLB56-Cx	\$20,884	830	\$12,608	CPB050JC-S-0-EV	\$8,276	120
KLB1010-Cx	\$33,340	1908	\$23,866	CPB075JC-S-4-EV	\$9,474	208-230
KLB1012-Cx	\$35,754	2123	\$26,280	CPB075JC-S-4-EV	\$9,474	208-230
KLB1014-Cx	\$39,535	2337	\$29,427	CPB100JC-S-4-EV	\$10,108	208-230
-10° F FREEZER WITH CEILING MOUNT CAPSULE PAK™ REFRIGERATION						
KLF46-Cx	\$22,219	907	\$11,259	CPF075JC-S-4-EV	\$10,960	208-230
KLF56-Cx	\$23,938	922	\$12,978	CPF075JC-S-4-EV	\$10,960	208-230
KLF1010-Cx	\$38,563	2071	\$24,329	CPF200JC-S-4-EV	\$14,234	208-230
KLF1012-Cx	\$41,024	2286	\$26,790	CPF200JC-S-4-EV	\$14,234	208-230
KLF1014-Cx	\$44,232	2500	\$29,998	CPF200JC-S-4-EV	\$14,234	208-230
<i>X=R for Right Hand Door or L for Left Hand Door</i>						

* Designed for 0°F Operation

INDOOR UTILITY COOLERS AND FREEZERS CEILING MOUNT CAPSULE PAK™ REFRIGERATION

7'- 4" HIGH, FLOORLESS MODELS
WITH 4" HFC free HFO POLYURETHANE INSULATED PANELS

Model Number	Kold Locker™ List Total Panels & Refrig	Kold Locker™ Total Ship Wt.	Kold Locker™ Panels Only List	Refrigeration Series	Refrigeration System Only List	Refrigeration Voltage 60/Hz
+35° F COOLER WITH CEILING MOUNT CAPSULE PAK™ REFRIGERATION						
KLB7446-Cx	\$19,076	758	\$10,800	CPB050JC-S-0-EV	\$8,276	120
KLB7456-Cx	\$19,903	818	\$11,627	CPB050JC-S-0-EV	\$8,276	120
KLB741010-Cx	\$28,828	1679	\$19,354	CPB075JC-S-4-EV	\$9,474	208-230
KLB741012-Cx	\$31,267	1832	\$21,159	CPB100JC-S-4-EV	\$10,108	208-230
KLB741014-Cx	\$32,983	1985	\$22,875	CPB100JC-S-4-EV	\$10,108	208-230
<i>X=R for Right Hand Door or L for Left Hand Door</i>						

- **Export crating available as an option. Consult factory for pricing.**
- **OPTIONAL REMOTE CAPSULE PAK™ Refrigeration Systems:** Include ambient controls, weather-proof hoods, pre-charged systems with quick connects for simple field connections to pre-charged lines of your choice. Consult factory for application, pricing and ship date availability.
- **SHELVING:** See p. 20 for pricing and shipping weights. Nor-Lake shelving utilizes a support clip to eliminate center posts to maximize usable square footage.
- **WARRANTY INFORMATION:** See p. 44



KOLD LOCKER™ WALK-INS

INDOOR UTILITY COOLERS AND FREEZERS CEILING MOUNT CAPSULE PAK™ REFRIGERATION

8'- 4" HIGH, FLOORLESS MODELS
WITH 4" HFC free HFO POLYURETHANE INSULATED PANELS

Model Number	Kold Locker™ List Total Panels & Refrig	Kold Locker™ Total Ship Wt.	Kold Locker™ Panels Only List	Refrigeration Series	Refrigeration System Only List	Refrigeration Voltage 60/Hz
+35° F COOLER WITH CEILING MOUNT CAPSULE PAK™ REFRIGERATION						
KLB8466-Cx	\$20,588	980	\$12,312	CPB050JC-S-0-EV	\$8,276	208-230
KLB8468-Cx	\$22,291	1260	\$14,015	CPB050JC-S-0-EV	\$8,276	208-230
KLB84610-Cx	\$24,737	1404	\$15,263	CPB075JC-S-4-EV	\$9,474	208-230
KLB84612-Cx	\$26,453	1537	\$16,979	CPB075JC-S-4-EV	\$9,474	208-230
KLB84614-Cx	\$28,446	1788	\$18,338	CPB100JC-S-4-EV	\$10,108	208-230
KLB8488-Cx	\$25,531	1405	\$16,057	CPB075JC-S-4-EV	\$9,474	208-230
KLB84810-Cx	\$26,850	1562	\$17,376	CPB075JC-S-4-EV	\$9,474	208-230
KLB84812-Cx	\$29,328	1826	\$19,220	CPB100JC-S-4-EV	\$10,108	208-230
KLB84814-Cx	\$30,647	1983	\$20,539	CPB100JC-S-4-EV	\$10,108	208-230
X=R for Right Hand Door or L for Left Hand Door						

- **Export crating available as an option. Consult factory for pricing.**
- **OPTIONAL REMOTE CAPSULE PAK™ Refrigeration Systems:** Include ambient controls, weather-proof hoods, pre-charged systems with quick connects for simple field connections to pre-charged lines of your choice. Consult factory for application, pricing and ship date availability.
- **SHELVING:** See p. 20 for pricing and shipping weights. Nor-Lake shelving utilizes a support clip to eliminate center posts to maximize usable square footage.
- **WARRANTY INFORMATION:** See p. 44



KOLD LOCKER™ WALK-INS

INDOOR UTILITY COOLERS AND FREEZERS CEILING MOUNT CAPSULE PAK™ REFRIGERATION

7'- 7" HIGH, WITH FLOOR MODELS
WITH 4" HFC free HFO POLYURETHANE INSULATED PANELS

Model Number	Kold Locker™ List Total Panels & Refrig	Kold Locker™ Total Ship Wt.	Kold Locker™ Panels Only List	Refrigeration Series	Refrigeration System Only List	Refrigeration Voltage 60/Hz
+35° F COOLER WITH CEILING MOUNT CAPSULE PAK™ REFRIGERATION						
KLB7746-Cx	\$19,817	803	\$11,541	CPB050JC-S-0-EV	\$8,276	120
KLB7748-Cx	\$22,204	940	\$13,928	CPB050JC-S-0-EV	\$8,276	120
KLB7756-Cx	\$21,246	878	\$12,970	CPB050JC-S-0-EV	\$8,276	120
KLB771010-Cx	\$34,620	2033	\$24,512	CPB100JC-S-4-EV	\$10,108	208-230
KLB771012-Cx	\$37,100	2260	\$26,992	CPB100JC-S-4-EV	\$10,108	208-230
KLB771014-Cx	\$40,383	2487	\$30,275	CPB100JC-S-4-EV	\$10,108	208-230
-10° F FREEZER WITH CEILING MOUNT CAPSULE PAK™ REFRIGERATION						
KLF7746-Cx	\$22,772	917	\$11,812	CPF075JC-S-4-EV	\$10,960	208-230
KLF7748-Cx	\$25,188	1205	\$14,228	CPF075JC-S-4-EV	\$10,960	208-230
KLF7756-Cx	\$24,261	1135	\$13,301	CPF075JC-S-4-EV	\$10,960	208-230
KLF771010-Cx	\$39,222	2197	\$24,988	CPF200JC-S-4-EV	\$14,234	208-230
KLF771012-Cx	\$41,750	2424	\$27,516	CPF200JC-S-4-EV	\$14,234	208-230
KLF771014-Cx	\$45,097	2651	\$30,863	CPF200JC-S-4-EV	\$14,234	208-230
X=R for Right Hand Door or L for Left Hand Door						

- **Export crating available as an option. Consult factory for pricing.**
- **OPTIONAL REMOTE CAPSULE PAK™ Refrigeration Systems:** Include ambient controls, weather-proof hoods, pre-charged systems with quick connects for simple field connections to pre-charged lines of your choice. Consult factory for application, pricing and ship date availability.
- **SHELVING:** See p. 20 for pricing and shipping weights. Nor-Lake shelving utilizes a support clip to eliminate center posts to maximize usable square footage.
- **WARRANTY INFORMATION:** See p. 44



KOLD LOCKER™ WALK-INS

OUTDOOR UTILITY COOLERS AND FREEZERS CEILING MOUNT CAPSULE PAK™ REFRIGERATION

6'- 7" HIGH, WITH FLOOR MODELS
WITH 4" HFC free HFO POLYURETHANE INSULATED PANELS

Model Number	Kold Locker™ List Total Panels & Refrig	Kold Locker™ Total Ship Wt.	Kold Locker™ Panels Only List	Refrigeration Series	Refrigeration System Only List	Refrigeration Voltage 60/Hz
+35° F COOLER WITH CEILING MOUNT CAPSULE PAK™ REFRIGERATION						
KODB46-Cx	\$20,381	847	\$11,417	CPB050JC-E-0-EV	\$8,964	120
KODB56-Cx	\$22,104	1043	\$13,140	CPB050JC-E-0-EV	\$8,964	120
KODB1010-Cx	\$35,461	1988	\$24,928	CPB100JC-E-4-EV	\$10,533	208-230
KODB1012-Cx	\$38,037	2208	\$27,504	CPB100JC-E-4-EV	\$10,533	208-230
KODB1014-Cx	\$41,362	2427	\$30,829	CPB100JC-E-4-EV	\$10,533	208-230
-10° F FREEZER WITH CEILING MOUNT CAPSULE PAK™ REFRIGERATION						
KODF46-Cx	\$23,632	958	\$11,686	CPF060JC-E-4-EV	\$11,946	208-230
KODF56-Cx	\$25,656	923	\$13,520	CPF075JC-E-4-EV	\$12,136	208-230
KODF1010-Cx	\$40,313	2181	\$25,412	CPF200JC-E-4-EV	\$14,901	208-230
KODF1012-Cx	\$42,939	2401	\$28,038	CPF200JC-E-4-EV	\$14,901	208-230
KODF1014-Cx	\$46,329	2652	\$31,428	CPF200JC-E-4-EV	\$14,901	208-230

X=R for Right Hand Door or L for Left Hand Door

OUTDOOR UTILITY COOLERS AND FREEZERS CEILING MOUNT CAPSULE PAK™ REFRIGERATION

7'- 7" HIGH, WITH FLOOR MODELS
WITH 4" HFC free HFO POLYURETHANE INSULATED PANELS

Model Number	Kold Locker™ List Total Panels & Refrig	Kold Locker™ Total Ship Wt.	Kold Locker™ Panels Only List	Refrigeration Series	Refrigeration System Only List	Refrigeration Voltage 60/Hz
+35° F COOLER WITH CEILING MOUNT CAPSULE PAK™ REFRIGERATION						
KODB7746-Cx	\$20,924	1007	\$11,960	CPB050JC-E-0-EV	\$8,964	208-230
KODB7756-Cx	\$22,589	1098	\$13,625	CPB050JC-E-0-EV	\$8,964	208-230
KODB771010-Cx	\$36,107	2114	\$25,574	CPB100JC-E-4-EV	\$10,533	208-230
KODB771012-Cx	\$38,749	2346	\$28,216	CPB100JC-E-4-EV	\$10,533	208-230
KODB771014-Cx	\$42,210	2578	\$31,677	CPB100JC-E-4-EV	\$10,533	208-230
-10° F FREEZER WITH CEILING MOUNT CAPSULE PAK™ REFRIGERATION						
KODF7746-Cx	\$24,328	1013	\$12,192	CPF075JC-E-4-EV	\$12,136	208-230
KODF7756-Cx	\$26,026	1138	\$13,890	CPF075JC-E-4-EV	\$12,136	208-230
KODF771010-Cx	\$40,972	2227	\$26,071	CPF200JC-E-4-EV	\$14,901	208-230
KODF771012-Cx	\$43,665	2571	\$28,764	CPF200JC-E-4-EV	\$14,901	208-230
KODF771014-Cx	\$47,193	2803	\$32,292	CPF200JC-E-4-EV	\$14,901	208-230

X=R for Right Hand Door or L for Left Hand Door

- Export crating available as an option. Consult factory for pricing.
- OPTIONAL REMOTE CAPSULE PAK™ Refrigeration Systems: Include ambient controls, weather-proof hoods, pre-charged systems with quick connects for simple field connections to pre-charged lines of your choice. Consult factory for application, pricing and ship date availability.
- SHELVING: See p. 20 for pricing and shipping weights. Nor-Lake shelving utilizes a support clip to eliminate center posts to maximize usable square footage.
- WARRANTY INFORMATION: See p. 44

Kold Locker™ Options and Accessories

Floor Plate Kits (fits all door locations within basic shape) include 1/8" smooth aluminum plate and cove moulding		
Model (Shape)	List Price	
KL45-SMPLT	\$658	
KL46-SMPLT	\$721	
KL48-SMPLT	\$927	
KL56-SMPLT	\$870	
KL66-SMPLT	\$1,030	
KL68-SMPLT	\$1,413	
KL610-SMPLT	\$1,621	
KL612-SMPLT	\$1,801	
KL614-SMPLT	\$2,189	
KL88-SMPLT	\$2,644	
KL810-SMPLT	\$2,160	
KL812-SMPLT	\$2,554	
KL814-SMPLT	\$2,957	

30" High Kickplate, Installed	Part Number	List Price
26" wide stainless steel exterior	123109	\$266
26" wide stainless steel interior	123110	\$244
26" wide 1/8" aluminum diamond tread exterior	127223	\$401
26" wide 1/8" aluminum diamond tread interior	127225	\$290

Additional Accessories	Part Number	List Price
Exterior ramp (for all with-floor models)	108833	\$871
*Heater Kit (for outdoor cooler applications where ambient temperatures range below 32°F)	032765	\$1,652
26" or 30" strip curtain (shipped loose)	103025	\$196
36" strip curtain (shipped loose)	103026	\$226
Door rain hoods, fits 26", 30" and 36" (shipped loose)	032556	\$55
Non-Skid Floor Strips (shipped loose)	000695	\$10

Consult Factory On Lead Times For Kickplate Options

* Required on coolers located outdoors where the ambient temperature is below freezing (+32°F).

- **Export crating available as an option. Consult factory for pricing.**
- **OPTIONAL REMOTE CAPSULE PAK™ Refrigeration Systems:** Include ambient controls, weather-proof hoods, pre-charged systems with quick connects for simple field connections to pre-charged lines of your choice. Consult factory for application, pricing and ship date availability.
- **SHELVING:** See p. 20 for pricing and shipping weights. Nor-Lake shelving utilizes a support clip to eliminate center posts to maximize usable square footage.
- **WARRANTY INFORMATION:** See p. 44

Walk-In Shelving Kits

Product Number	Description	Walk-in Model	Shipping	List Price
SSG46-3	Green-Kote Shelving Kit™ 3 tier	4' x 6'	125	\$872
SSG46-4	Green-Kote Shelving Kit™ 4 tier	4' x 6'	165	\$1,050
SSG48-3	Green-Kote Shelving Kit™ 3 tier	4' x 8'	150	\$1,022
SSG48-4	Green-Kote Shelving Kit™ 4 tier	4' x 8'	200	\$1,253
SSG56-3	Green-Kote Shelving Kit™ 3 tier	5' x 6'	165	\$1,017
SSG56-4	Green-Kote Shelving Kit™ 4 tier	5' x 6'	195	\$1,249
SSG66-3	Green-Kote Shelving Kit™ 3 tier	6' x 6'	193	\$1,164
SSG66-4	Green-Kote Shelving Kit™ 4 tier	6' x 6'	202	\$1,431
SSG68-3	Green-Kote Shelving Kit™ 3 tier	6' x 8'	245	\$1,579
SSG68-4	Green-Kote Shelving Kit™ 4 tier	6' x 8'	270	\$1,953
SSG610-3	Green-Kote Shelving Kit™ 3 tier	6' x 10'	265	\$1,798
SSG610-4	Green-Kote Shelving Kit™ 4 tier	6' x 10'	285	\$2,248
SSG612-3	Green-Kote Shelving Kit™ 3 tier	6' x 12'	284	\$2,049
SSG612-4	Green-Kote Shelving Kit™ 4 tier	6' x 12'	348	\$2,583
SSG614-3	Green-Kote Shelving Kit™ 3 tier	6' x 14'	335	\$2,454
SSG614-4	Green-Kote Shelving Kit™ 4 tier	6' x 14'	411	\$3,092
SSG88-3	Green-Kote Shelving Kit™ 3 tier	8' x 8'	276	\$1,838
SSG88-4	Green-Kote Shelving Kit™ 4 tier	8' x 8'	339	\$2,304
SSG810-3	Green-Kote Shelving Kit™ 3 tier	8' x 10'	335	\$2,149
SSG810-4	Green-Kote Shelving Kit™ 4 tier	8' x 10'	416	\$2,728
SSG812-3	Green-Kote Shelving Kit™ 3 tier	8' x 12'	394	\$2,527
SSG812-4	Green-Kote Shelving Kit™ 4 tier	8' x 12'	493	\$3,215
SSG814-3	Green-Kote Shelving Kit™ 3 tier	8' x 14'	453	\$2,952
SSG814-4	Green-Kote Shelving Kit™ 4 tier	8' x 14'	570	\$3,758

- Use SSG77XXX-4 for 72" tall posts
- For use in floor or floorless walk-in of at least 6' 4" over all height
- When ordering shelving please indicate door locations for walk-ins larger than 6'

STANDARD DOOR LOCATION CHART

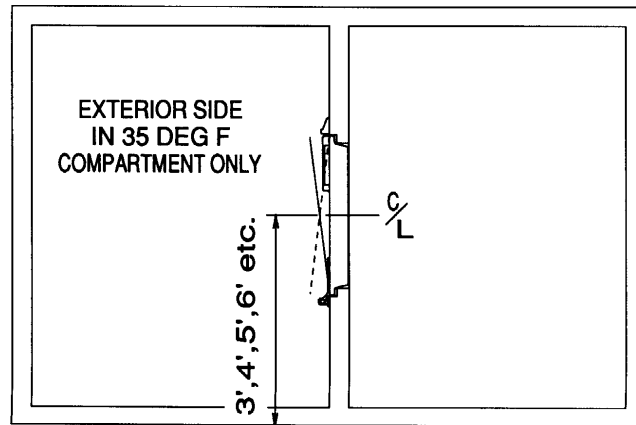
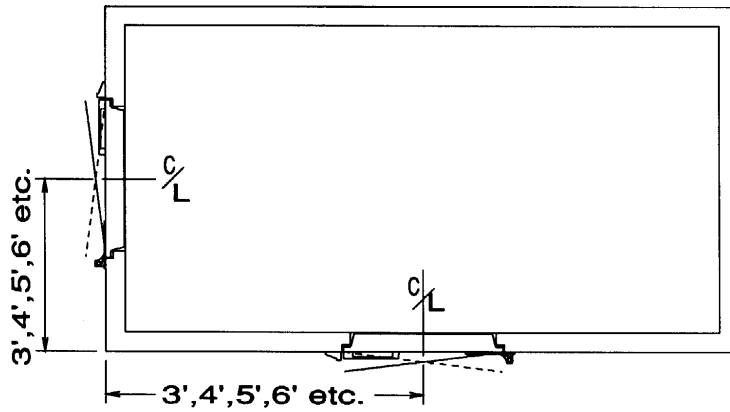

NOTE: EXTERIOR SIDE OF DOOR (HANDLE SIDE) IN THE PARTITION WALL MUST BE IN 35 DEG F. COMPARTMENT SIDE.

DIMENSION CHART FOR COMBINATION MODELS

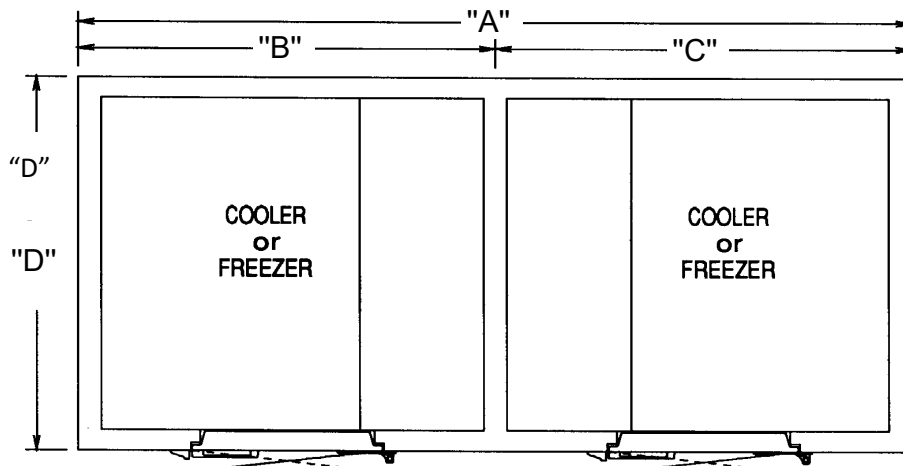



FAST-TRAK® WALK-INS

Single Compartment Walk-Ins

LIST PRICING IS FOR PANELS ONLY. REFRIGERATION SYSTEMS MUST BE ADDED SEPARATELY.

SIZE W X L	INDOOR 6' WIDE MODELS												
	WITH FLOOR		REFRIGERATION SIZING WITH FLOOR						LESS FLOOR (UNINSULATED)				
	7' - 7"	8' - 7"	+35 F.			-10 F.			7' - 4"	8' - 4"	+35 F.		
List	List	Normal	Heavy	Capsule Pak	Normal	Heavy	Capsule Pak	List	List	Normal	Heavy	Capsule Pak	
6' X 6'	\$12,920	\$13,388	MHMD005AB E1MD0060A-TA2	MHMD005AB E1MD0060A-TA2	CPB050JC-S-0-EV	MSLD015A E1LD0056B-TE2	MSLD017A E1LD0076B-TE2	CPF100JC-S-4-EV	\$11,508	\$11,967	MHMD007AB E1MD0060A-TA	MHMD007AB E1MD0078A-TA	CPB050JC-S-0-EV
6' X 7'	\$15,043	\$15,569	MHMD005AB E1MD0060A-TA2	MHMD005AB E1MD0060A-TA2	CPB050JC-S-0-EV	MSLD015A E1LD0056B-TE2	MSLD017A E1LD0076B-TE2	CPF100JC-S-4-EV	\$13,013	\$13,529	MHMD007AB E1MD0060A-TA	MHMD007AB E1MD0078A-TA	CPB050JC-S-0-EV
6' X 8'	\$14,911	\$15,471	MHMD005ABB E1MD0060A-TA2	MHMD005ABB E1MD0060A-TA2	CPB050JC-S-0-EV	MSLD015A E1LD0056B-TE2	MSLD017A E1LD0076B-TE2	CPF100JC-S-4-EV	\$13,194	\$13,706	MHMD007AB E1MD0060A-TA	MHMD007AB E1MD0078A-TA	CPB050JC-S-0-EV
6' X 9'	\$16,429	\$17,030	MHMD005ABB E1MD0060A-TA2	MHMD007AB E1MD0078A-TA2	CPB075JC-S-4-EV	MSLD015A E1LD0056B-TE2	MSLD017A E1LD0076B-TE2	CPF150JC-S-4-EV	\$14,130	\$14,734	MHMD007AB E1MD0078A-TA	MHMD007AB E1MD0078A-TA	CPB075JC-S-4-EV
6' X 10'	\$16,955	\$17,590	MHMD007AB E1MD0078A-TA2	MHMD007AB E1MD0078A-TA2	CPB075JC-S-4-EV	MSLD017A E1LD0076B-TE2	*MSLD020A E1LD0088B-TE2	CPF150JC-S-4-EV	\$14,478	\$15,123	MHMD007AB E1MD0078A-TA	MHMD007AB E1MD0078A-TA	CPB075JC-S-4-EV
6' X 11'	\$18,191	\$18,884	MHMD007AB E1MD0078A-TA2	MHMD007AB E1MD0078A-TA2	CPB075JC-S-4-EV	MSLD017A E1LD0076B-TE2	*MSLD020A E1LD0088B-TE2	CPF150JC-S-4-EV	\$15,507	\$16,191	MHMD007AB E1MD0078A-TA	MHMD007AB E1MD0078A-TA	CPB075JC-S-4-EV
6' X 12'	\$18,945	\$19,674	MHMD007AB E1MD0078A-TA2	MHMD007AB E1MD0078A-TA2	CPB075JC-S-4-EV	MSLD017A E1LD0076B-TE2	*MSLD025A E1LD0106B-TE2	CPF150JC-S-4-EV	\$16,107	\$16,827	*MHMD007AB E1MD0078A-TA	MHMD007AB E1MD0078A-TA	CPB075JC-S-4-EV
6' X 13'	\$20,464	\$21,232	MHMD007AB E1MD0078A-TA2	MHMD007AB E1MD0078A-TA2	CPB075JC-S-4-EV	MSLD017A E1LD0076B-TE2	MSLD025A E1LD0106B-TE2	CPF150JC-S-4-EV	\$17,008	\$17,798	MHMD007AB E1MD0078A-TA	*MHMD010A E1MD0085A-TA	CPB075JC-S-4-EV
6' X 14'	\$20,989	\$21,792	MHMD007AB E1MD0078A-TA2	MHMD007AB E1MD0078A-TA2	CPB075JC-S-4-EV	MSLD017A E1LD0076B-TE2	MSLD025A E1LD0106B-TE2	CPF200JC-S-4-EV	\$17,431	\$18,199	MHMD007AB E1MD0078A-TA	MHMD010A E1MD0085A-TA	CPB100JC-S-4-EV
6' X 15'	\$22,225	\$23,086	MHMD007AB E1MD0078A-TA2	MHMD007AB E1MD0078A-TA2	NA	MSLD017A E1LD0076B-TE2	MSLD025A E1LD0106B-TE2	NA	\$18,499	\$19,285	MHMD007AB E1MD0078A-TA	MHMD010A E1MD0085A-TA	NA
6' X 16'	\$22,980	\$23,876	MHMD007AB E1MD0078A-TA2	MHMD007AB E1MD0078A-TA2	NA	MSLD017A E1LD0076B-TE2	MSLD025A E1LD0106B-TE2	NA	\$19,073	\$19,965	MHMD007AB E1MD0078A-TA	*MHMD010A E1MD0085A-TA	NA
6' X 17'	\$24,498	\$25,430	MHMD007AB E1MD0078A-TA2	MHMD010A E1MD0085A-TA2	NA	*MSLD020A E1LD0088B-TE2	MSLD025A E1LD0106B-TE2	NA	\$19,961	\$20,888	MHMD007AB E1MD0078A-TA	*MHMD010A E1MD0085A-TA	NA
6' X 18'	\$25,024	\$25,995	MHMD007AB E1MD0078A-TA2	MHMD010A E1MD0085A-TA2	NA	*MSLD025A E1LD0106B-TE2	MSLD030A E1LD0106B-TE2	NA	\$20,340	\$21,289	MHMD007AB E1MD0078A-TA	MSMD012A E1MD0109A-TA	NA
6' X 19'	\$26,259	\$27,288	MHMD007AB E1MD0078A-TA2	MHMD010A E1MD0085A-TA2	NA	*MSLD025A E1LD0106B-TE2	MSLD030A E1LD0106B-TE2	NA	\$21,382	\$22,388	*MHMD010A E1MD0085A-TA	MSMD012A E1MD0109A-TA	NA
6' X 20'	\$27,014	\$28,078	MHMD007AB E1MD0078A-TA2	MHMD010A E1MD0085A-TA2	NA	MSLD025A E1LD0106B-TE2	MSLD030A E1LD0106B-TE2	NA	\$22,026	\$23,068	MHMD010A E1MD0085A-TA	MSMD012A E1MD0109A-TA	NA

SIZE W X L	OUTDOOR 6' WIDE MODELS												
	WITH FLOOR		REFRIGERATION SIZING WITH FLOOR						LESS FLOOR (UNINSULATED)				
	7' - 7"	8' - 7"	+35 F.			-10 F.			7' - 4"	8' - 4"	+35 F.		
List	List	Normal	Heavy	Capsule Pak	Normal	Heavy	Capsule Pak	List	List	Normal	Heavy	Capsule Pak	
6' X 6'	\$13,277	\$13,745	MHMD005AB E1MD0060A-TA2	MHMD007AB E1MD0078A-TA2	CPB050JC-E-0-EV	MSLD015A E1LD0056B-TE2	MSLD017A E1LD0076B-TE2	CPF100JC-E-4-EV					
6' X 7'	\$15,459	\$15,985	MHMD005AB E1MD0060A-TA2	MHMD007AB E1MD0078A-TA2	CPB050JC-E-0-EV	*MSLD017A E1LD0076B-TE2	MSLD017A E1LD0076B-TE2	CPF100JC-E-4-EV					
6' X 8'	\$15,386	\$15,947	MHMD005AB E1MD0060A-TA2	MHMD007AB E1MD0078A-TA2	CPB050JC-E-0-EV	MSLD017A E1LD0076B-TE2	*MSLD020A E1LD0088B-TE2	CPF100JC-E-4-EV					
6' X 9'	\$16,964	\$17,564	MHMD007AB E1MD0078A-TA2	MHMD007AB E1MD0078A-TA2	CPB075JC-E-4-EV	MSLD017A E1LD0076B-TE2	*MSLD025A E1LD0106B-TE2	CPF150JC-E-4-EV					
6' X 10'	\$17,549	\$18,185	MHMD007AB E1MD0078A-TA2	MHMD007AB E1MD0078A-TA2	CPB075JC-E-4-EV	MSLD017A E1LD0076B-TE2	MSLD025A E1LD0106B-TE2	CPF150JC-E-4-EV					
6' X 11'	\$18,844	\$19,537	MHMD007AB E1MD0078A-TA2	MHMD007AB E1MD0078A-TA2	CPB075JC-E-4-EV	MSLD017A E1LD0076B-TE2	MSLD025A E1LD0106B-TE2	CPF150JC-E-4-EV					
6' X 12'	\$19,658	\$20,387	MHMD007AB E1MD0078A-TA2	*MHMD010A E1MD0085A-TA2	CPB100JC-E-4-EV	MSLD017A E1LD0076B-TE2	MSLD025A E1LD0106B-TE2	CPF150JC-E-4-EV					
6' X 13'	\$21,236	\$22,004	*MHMD007AB E1MD0078A-TA2	MHMD010A E1MD0085A-TA2	CPB100JC-E-4-EV	MSLD017A E1LD0076B-TE2	MSLD025A E1LD0106B-TE2	CPF150JC-E-4-EV					
6' X 14'	\$21,821	\$22,624	MHMD007AB E1MD0078A-TA2	MHMD010A E1MD0085A-TA2	CPB100JC-E-4-EV	*MSLD020A E1LD0088B-TE2	MSLD025A E1LD0106B-TE2	CPF200JC-E-4-EV					
6' X 15'	\$23,116	\$23,977	MHMD007AB E1MD0078A-TA2	*MSMD012A E1MD0109A-TA2	NA	*MSLD025A E1LD0106B-TE2	MSLD025A E1LD0106B-TE2	NA					
6' X 16'	\$23,931	\$24,827	MHMD007AB E1MD0078A-TA2	*MSMD012A E1MD0109A-TA2	NA	*MSLD025A E1LD0106B-TE2	MSLD025A E1LD0106B-TE2	NA					
6' X 17'	\$25,509	\$26,440	MHMD007AB E1MD0078A-TA2	MSMD012A E1MD0109A-TA2	NA	MSLD025A E1LD0106B-TE2	MSLD025A E1LD0106B-TE2	NA					
6' X 18'	\$26,093	\$27,064	MHMD007AB E1MD0078A-TA2	MSMD012A E1MD0109A-TA2	NA	MSLD025A E1LD0106B-TE2	MSLD030A E1LD0106B-TE2	NA					
6' X 19'	\$27,389	\$28,417	MHMD007AB E1MD0078A-TA2	MSMD012A E1MD0109A-TA2	NA	MSLD025A E1LD0106B-TE2	MSLD030A E1LD0106B-TE2	NA					
6' X 20'	\$28,203	\$29,267	MHMD007AB E1MD0078A-TA2	*MSMD015A E1MD0136A-TA2	NA	MSLD025A E1LD0106B-TE2	MSLD030A E1LD0106B-TE2	NA					

Refrigeration sizing based on 100°F. ambient temperature on all surfaces, outdoor location, (1) 36" x 78" door, **no product load** and 10% safety factor added, 16 hour run time on coolers and 20 hour on freezers. Price includes outdoor membrane roof for outdoor models.

NOTES:

Doors can be located in any standard location on any compartment wall surfaces as shown on STANDARD DOOR LOCATION CHART on page 21. Specify hinging and location when ordering.

For Remote Refrigeration pricing, refer to pages 41-42.



Single Compartment Walk-Ins

LIST PRICING IS FOR PANELS ONLY. REFRIGERATION SYSTEMS MUST BE ADDED SEPARATELY.

SIZE W X L	INDOOR 7' WIDE MODELS												
	WITH FLOOR			REFRIGERATION SIZING WITH FLOOR						LESS FLOOR (UNINSULATED)			
	7' - 7"	8' - 7"		+35 F.			-10 F.		7' - 4"	8' - 4"		+35 F.	
List	List		Normal	Heavy	Capsule Pak	Normal	Heavy	Capsule Pak	List	List	Normal	Heavy	Capsule Pak
7' X 7'	\$16,372	\$16,959	MHMD005AB E1MD0060A-TA2	MHMD005AB E1MD0060A-TA2	CPB075JC-S-4-EV	MSLD015A E1LD0056B-TE2	MSLD017A E1LD0076B-TE2	CPF100JC-S-4-EV	\$14,121	\$14,699	MHMD005AB E1MD0060A-TA2	MHMD007AB E1MD0078A-TA2	CPB075JC-S-4-EV
7' X 8'	\$16,257	\$16,875	MHMD005AB E1MD0060A-TA2	MHMD005AB E1MD0060A-TA2	CPB075JC-S-4-EV	*MSLD017A E1LD0076B-TE2	MSLD017A E1LD0076B-TE2	CPF150JC-S-4-EV	\$14,258	\$14,871	MHMD005AB E1MD0060A-TA2	MHMD007AB E1MD0078A-TA2	CPB075JC-S-4-EV
7' X 9'	\$17,846	\$18,504	MHMD005AB E1MD0060A-TA2	*MHMD007AB E1MD0078A-TA2	CPB075JC-S-4-EV	MSLD017A E1LD0076B-TE2	*MSLD020A E1LD0088B-TE2	CPF150JC-S-4-EV	\$15,277	\$15,926	MHMD007AB E1MD0078A-TA2	MHMD007AB E1MD0078A-TA2	CPB075JC-S-4-EV
7' X 10'	\$18,442	\$19,135	MHMD007AB E1MD0078A-TA2	MHMD007AB E1MD0078A-TA2	CPB075JC-S-4-EV	MSLD017A E1LD0076B-TE2	*MSLD025A E1LD0106B-TE2	CPF150JC-S-4-EV	\$15,661	\$16,345	MHMD007AB E1MD0078A-TA2	MHMD007AB E1MD0078A-TA2	CPB075JC-S-4-EV
7' X 11'	\$19,718	\$20,473	MHMD007AB E1MD0078A-TA2	MHMD007AB E1MD0078A-TA2	CPB075JC-S-4-EV	MSLD017A E1LD0076B-TE2	MSLD025A E1LD0106B-TE2	CPF150JC-S-4-EV	\$16,685	\$17,431	*MHMD007AB E1MD0078A-TA2	*MHMD010A E1MD0085A-TA2	CPB075JC-S-4-EV
7' X 12'	\$20,517	\$21,302	MHMD007AB E1MD0078A-TA2	MHMD007AB E1MD0078A-TA2	CPB075JC-S-4-EV	MSLD017A E1LD0076B-TE2	MSLD025A E1LD0106B-TE2	CPF150JC-S-4-EV	\$17,299	\$18,080	*MHMD007AB E1MD0078A-TA2	*MHMD010A E1MD0085A-TA2	CPB075JC-S-4-EV
7' X 13'	\$22,106	\$22,931	MHMD007AB E1MD0078A-TA2	MHMD007AB E1MD0078A-TA2	CPB075JC-S-4-EV	MSLD017A E1LD0076B-TE2	MSLD025A E1LD0106B-TE2	CPF150JC-S-4-EV	\$18,230	\$19,078	MHMD007AB E1MD0078A-TA2	*MHMD010AB E1MD0085A-TA2	CPB075JC-S-4-EV
7' X 14'	\$22,706	\$23,567	MHMD007AB E1MD0078A-TA2	MHMD007AB E1MD0078A-TA2	CPB075JC-S-4-EV	MSLD017A E1LD0076B-TE2	MSLD025A E1LD0106B-TE2	CPF200JC-S-4-EV	\$18,645	\$19,510	MHMD007AB E1MD0078A-TA2	*MSMD012AB E1MD0109A-TA2	CPB100JC-S-4-EV
7' X 15'	\$23,982	\$24,900	MHMD007AB E1MD0078A-TA2	*MHMD010A E1MD0085A-TA2	NA	*MSLD020A E1LD0088B-TE2	MSLD025A E1LD0106B-TE2	NA	\$19,700	\$20,609	MHMD007AB E1MD0078A-TA2	*MSMD012AB E1MD0109A-TA2	NA
7' X 16'	\$24,776	\$25,734	*MHMD007AB E1MD0078A-TA2	*MHMD010A E1MD0085A-TA2	NA	*MSLD025A E1LD0106B-TE2	MSLD025A E1LD0106B-TE2	NA	\$20,393	\$21,302	MHMD007AB E1MD0078A-TA2	*MSMD012AB E1MD0109A-TA2	NA
7' X 17'	\$26,365	\$27,359	MHMD007AB E1MD0078A-TA2	MHMD010A E1MD0085A-TA2	NA	*MSLD025A E1LD0106B-TE2	MSLD030A E1LD0106B-TE2	NA	\$21,298	\$22,256	*MSMD012AB E1MD0109A-TA2	*MSMD012AB E1MD0109A-TA2	NA
7' X 18'	\$26,966	\$27,994	MHMD007AB E1MD0078A-TA2	MHMD010A E1MD0085A-TA2	NA	MSLD025A E1LD0106B-TE2	MSLD030A E1LD0106B-TE2	NA	\$21,682	\$22,688	*MSMD012AB E1MD0109A-TA2	*MSMD015AB E1MD0136A-TA2	NA
7' X 19'	\$28,241	\$29,327	MHMD007AB E1MD0078A-TA2	*MSMD012A E1MD0109A-TA2	NA	MSLD025A E1LD0106B-TE2	MSLD030A E1LD0106B-TE2	NA	\$22,737	\$23,801	*MSMD012AB E1MD0109A-TA2	*MSMD015AB E1MD0136A-TA2	NA
7' X 20'	\$29,036	\$30,162	MHMD007AB E1MD0078A-TA2	*MSMD012A E1MD0109A-TA2	NA	MSLD025A E1LD0106B-TE2	MSLD030A E1LD0106B-TE2	NA	\$23,351	\$24,494	*MSMD012AB E1MD0109A-TA2	*MSMD017AB E1MD0153A-TA2	NA

SIZE W X L	OUTDOOR 7' WIDE MODELS												
	WITH FLOOR			REFRIGERATION SIZING WITH FLOOR									
	7' - 7"	8' - 7"		+35 F.			-10 F.						
List	List		Normal	Heavy	Capsule Pak	Normal	Heavy	Capsule Pak					
7' X 7'	\$16,857	\$17,444	MHMD005ABB E1MD0060A-TA2	MHMD007AB E1MD0078A-TA2	CPB075JC-E-4-EV	MSLD017A E1LD0076B-TA2	*MSLD020A E1LD0088B-TA2	CPF150JC-E-4-EV					
7' X 8'	\$16,812	\$17,430	MHMD005ABB E1MD0060A-TA2	MHMD007AB E1MD0078A-TA2	CPB075JC-E-4-EV	MSLD017A E1LD0076B-TA2	*MSLD025A E1LD0106B-TA2	CPF150JC-E-4-EV					
7' X 9'	\$18,470	\$19,128	MHMD007AB E1MD0078A-TA2	MHMD007AB E1MD0078A-TA2	CPB075JC-E-4-EV	MSLD017A E1LD0076B-TA2	MSLD025A E1LD0106B-TA2	CPF150JC-E-4-EV					
7' X 10'	\$19,135	\$19,828	MHMD007AB E1MD0078A-TA2	*MHMD010A E1MD0085A-TA2	CPB075JC-E-4-EV	MSLD017A E1LD0076B-TA2	MSLD025A E1LD0106B-TA2	CPF150JC-E-4-EV					
7' X 11'	\$20,480	\$21,235	*MHMD007AB E1MD0078A-TA2	MHMD010A E1MD0085A-TA2	CPB075JC-E-4-EV	MSLD017A E1LD0076B-TA2	MSLD025A E1LD0106B-TA2	CPF150JC-E-4-EV					
7' X 12'	\$21,349	\$22,134	MHMD007AB E1MD0078A-TA2	MHMD010A E1MD0085A-TA2	CPB100JC-E-4-EV	*MSLD020A E1LD0088B-TA2	MSLD025A E1LD0106B-TA2	CPF150JC-E-4-EV					
7' X 13'	\$23,007	\$23,833	MHMD007AB E1MD0078A-TA2	*MSMD012A E1MD0109A-TA2	CPB100JC-E-4-EV	*MSLD025A E1LD0106B-TA2	MSLD025A E1LD0106B-TA2	CPF200JC-E-4-EV					
7' X 14'	\$23,677	\$24,538	MHMD007AB E1MD0078A-TA2	*MSMD012A E1MD0109A-TA2	CPB100JC-E-4-EV	*MSLD025A E1LD0106B-TA2	MSLD025A E1LD0106B-TA2	CPF200JC-E-4-EV					
7' X 15'	\$25,022	\$25,940	MHMD007AB E1MD0078A-TA2	MSMD012A E1MD0109A-TA2	NA	MSLD025A E1LD0106B-TA2	MSLD030A E1LD0106B-TA2	NA					
7' X 16'	\$25,886	\$26,844	MHMD007AB E1MD0078A-TA2	MSMD012A E1MD0109A-TA2	NA	MSLD025A E1LD0106B-TA2	MSLD030A E1LD0106B-TA2	NA					
7' X 17'	\$27,544	\$28,537	MHMD007AB E1MD0078A-TA2	MSMD012A E1MD0109A-TA2	NA	MSLD025A E1LD0106B-TA2	MSLD030A E1LD0106B-TA2	NA					
7' X 18'	\$28,214	\$29,242	MHMD007AB E1MD0078A-TA2	*MSMD015A E1MD0136A-TA2	NA	MSLD025A E1LD0106B-TA2	MSLD030A E1LD0106B-TA2	NA					
7' X 19'	\$29,559	\$30,645	*MHMD010A E1MD0085A-TA2	*MSMD015A E1MD0136A-TA2	NA	MSLD030A E1LD0106B-TA2	MSLD030A E1LD0106B-TA2	NA					
7' X 20'	\$30,423	\$31,548	*MHMD010A E1MD0085A-TA2	*MSMD017A E1MD0153A-TA2	NA	MSLD030A E1LD0106B-TA2	*MSMD030A E1MD0278A-TA2	NA					

Refrigeration sizing based on 100°F. ambient temperature on all surfaces, outdoor location, (1) 36" x 78" door, **no product load** and 10% safety factor added, 16 hour run time on coolers and 20 hour on freezers. Price includes outdoor membrane roof for outdoor models.

NOTES:

Doors can be located in any standard location on any compartment wall surfaces as shown on STANDARD DOOR LOCATION CHART on page 21. Specify hinging and location when ordering.

For Remote Refrigeration pricing, refer to pages 41-42.



FAST-TRAK® WALK-INS

Single Compartment Walk-Ins

LIST PRICING IS FOR PANELS ONLY. REFRIGERATION SYSTEMS MUST BE ADDED SEPARATELY.

SIZE W X L	INDOOR 8' WIDE MODELS												
	WITH FLOOR		REFRIGERATION SIZING WITH FLOOR						LESS FLOOR (UNINSULATED)				
	7' - 7"	8' - 7"	+35 F.			-10 F.			7' - 4"	8' - 4"	+35 F.		
	List	List	Normal	Heavy	Capsule Pak	Normal	Heavy	Capsule Pak	List	List	Normal	Heavy	Capsule Pak
8' X 8'	\$17,074	\$17,731	MHMD005AB E1MD0060A-TA2	*MHMD007AB E1MD0078A-TA2	CPB075JC-S-4-EV	MSLD017A E1LD0076B-TE2	*MSLD020A E1LD0088B-TE2	CPF150JC-S-4-EV	\$14,880	\$15,529	MHMD007AB E1MD0078A-TE2	MHMD007AB E1MD0078A-TE2	CPB075JC-S-4-EV
8' X 9'	\$18,716	\$19,409	MHMD005AB E1MD0060A-TA2	MHMD007AB E1MD0078A-TA2	CPB075JC-S-4-EV	MSLD017A E1LD0076B-TE2	*MSLD025A E1LD0106B-TE2	CPF150JC-S-4-EV	\$15,882	\$16,566	MHMD007AB E1MD0078A-TE2	MHMD007AB E1MD0078A-TE2	CPB075JC-S-4-EV
8' X 10'	\$19,338	\$20,066	MHMD007AB E1MD0078A-TA2	MHMD007AB E1MD0078A-TA2	CPB075JC-S-4-EV	MSLD017A E1LD0076B-TE2	MSLD025A E1LD0106B-TE2	CPF150JC-S-4-EV	\$16,328	\$17,047	MHMD007AB E1MD0078A-TE2	*MHMD010A E1MD0085A-TE2	CPB075JC-S-4-EV
8' X 11'	\$20,680	\$21,470	MHMD007AB E1MD0078A-TA2	MHMD007AB E1MD0078A-TA2	CPB075JC-S-4-EV	MSLD017A E1LD0076B-TE2	MSLD025A E1LD0106B-TE2	CPF150JC-S-4-EV	\$17,383	\$18,164	MHMD007AB E1MD0078A-TE2	MHMD010A E1MD0085A-TE2	CPB075JC-S-4-EV
8' X 12'	\$21,519	\$22,344	MHMD007AB E1MD0078A-TA2	MHMD007AB E1MD0078A-TA2	**CPB100JC-S-4-EV	MSLD017A E1LD0076B-TE2	MSLD025A E1LD0106B-TE2	CPF200JC-S-4-EV	\$18,001	\$18,813	MHMD007AB E1MD0078A-TE2	MHMD010A E1MD0085A-TE2	**CPB100JC-S-4-EV
8' X 13'	\$23,152	\$24,026	MHMD007AB E1MD0078A-TA2	MHMD007AB E1MD0078A-TA2	CPB100JC-S-4-EV	*MSLD020A E1LD0088B-TE2	MSLD025A E1LD0106B-TE2	CPF200JC-S-4-EV	\$18,985	\$19,837	MHMD007AB E1MD0078A-TE2	MSMD012A E1MD0109A-TE2	CPB100JC-S-4-EV
8' X 14'	\$23,783	\$24,679	MHMD007AB E1MD0078A-TA2	*MHMD010A E1MD0085A-TA2	CPB100JC-S-4-EV	MSLD020A E1LD0088B-TE2	MSLD030A E1LD0106B-TE2	CPF200JC-S-4-EV	\$19,387	\$20,278	MHMD007AB E1MD0078A-TE2	MSMD012A E1MD0109A-TE2	CPB100JC-S-4-EV
8' X 15'	\$25,125	\$26,083	MHMD007AB E1MD0078A-TA2	MHMD010A E1MD0085A-TA2	NA	*MSLD025A E1LD0106B-TE2	MSLD030A E1LD0106B-TE2	NA	\$20,459	\$21,408	*MHMD010A E1MD0085A-TE2	*MSMD012A E1MD0109A-TE2	NA
8' X 16'	\$25,964	\$26,957	MHMD007AB E1MD0078A-TA2	MHMD010A E1MD0085A-TA2	NA	MSLD025A E1LD0106B-TE2	MSLD030A E1LD0106B-TE2	NA	\$21,091	\$22,075	MHMD010A E1MD0085A-TE2	*MSMD015A E1MD0136A-TE2	NA
8' X 17'	\$27,610	\$28,639	MHMD007AB E1MD0078A-TA2	*MSMD012A E1MD0109A-TA2	NA	MSLD025A E1LD0106B-TE2	MSLD030A E1LD0106B-TE2	NA	\$22,044	\$23,064	MHMD010A E1MD0085A-TE2	MSMD015A E1MD0136A-TE2	NA
8' X 18'	\$28,228	\$29,292	MHMD007AB E1MD0078A-TA2	*MSMD012A E1MD0109A-TA2	NA	MSLD025A E1LD0106B-TE2	MSLD030A E1LD0106B-TE2	NA	\$22,507	\$23,562	*MSMD012A E1MD0109A-TE2	*MSMD017A E1MD0153A-TE2	NA
8' X 19'	\$29,574	\$30,696	MHMD007AB E1MD0078A-TA2	MSMD012A E1MD0109A-TA2	NA	MSLD025A E1LD0106B-TE2	MSLD030A E1LD0106B-TE2	NA	\$23,576	\$24,692	MSMD012A E1MD0109A-TE2	MSMD017A E1MD0153A-TE2	NA
8' X 20'	\$30,413	\$31,570	MHMD007AB E1MD0078A-TA2	MSMD012A E1MD0109A-TA2	NA	MSLD025A E1LD0106B-TE2	MSLD030A E1LD0106B-TE2	NA	\$24,194	\$25,346	MSMD012A E1MD0109A-TE2	MSMD017A E1MD0153A-TE2	NA

SIZE W X L	OUTDOOR 8' WIDE MODELS											
	WITH FLOOR		REFRIGERATION SIZING WITH FLOOR									
	7' - 7"	8' - 7"	+35 F.			-10 F.						
	List	List	Normal	Heavy	Capsule Pak	Normal	Heavy	Capsule Pak				
8' X 8'	\$17,708	\$18,365	MHMD007AB E1MD0078A-TA2	MHMD007AB E1MD0078A-TA2	CPB075JC-E-4-EV	MSLD017A E1LD0076B-TE2	MSLD025A E1LD0106B-TE2	CPF150JC-E-4-EV				
8' X 9'	\$19,429	\$20,122	MHMD007AB E1MD0078A-TA2	*MHMD010A E1MD0085A-TA2	CPB075JC-E-4-EV	MSLD017A E1LD0076B-TE2	MSLD025A E1LD0106B-TE2	CPF150JC-E-4-EV				
8' X 10'	\$20,131	\$20,859	MHMD007AB E1MD0078A-TA2	MHMD010A E1MD0085A-TA2	CPB075JC-E-4-EV	MSLD017A E1LD0076B-TE2	MSLD025A E1LD0106B-TE2	CPF150JC-E-4-EV				
8' X 11'	\$21,552	\$22,342	MHMD007AB E1MD0078A-TA2	MHMD010A E1MD0085A-TA2	CPB100JC-E-4-EV	*MSLD020A E1LD0088B-TE2	MSLD025A E1LD0106B-TE2	CPF150JC-E-4-EV				
8' X 12'	\$22,470	\$23,295	MHMD007AB E1MD0078A-TA2	*MSMD012A E1MD0109A-TA2	CPB100JC-E-4-EV	*MSLD025A E1LD0106B-TE2	MSLD025A E1LD0106B-TE2	CPF200JC-E-4-EV				
8' X 13'	\$24,182	\$25,056	MHMD007AB E1MD0078A-TA2	MSMD012A E1MD0109A-TA2	CPB100JC-E-4-EV	MSLD025A E1LD0106B-TE2	MSLD030A E1LD0106B-TE2	CPF200JC-E-4-EV				
8' X 14'	\$24,893	\$25,789	MHMD007AB E1MD0078A-TA2	MSMD012A E1MD0109A-TA2	CPB100JC-E-4-EV	MSLD025A E1LD0106B-TE2	MSLD030A E1LD0106B-TE2	CPF200JC-E-4-EV				
8' X 15'	\$26,314	\$27,272	MHMD007AB E1MD0078A-TA2	MSMD012A E1MD0109A-TA2	NA	MSLD025A E1LD0106B-TE2	MSLD030A E1LD0106B-TE2	NA				
8' X 16'	\$27,232	\$28,225	MHMD007AB E1MD0078A-TA2	*MSMD015A E1MD0136A-TA2	NA	MSLD025A E1LD0106B-TE2	MSLD030A E1LD0106B-TE2	NA				
8' X 17'	\$28,957	\$29,986	*MHMD010A E1MD0085A-TA2	*MSMD015A E1MD0136A-TA2	NA	MSLD030A E1LD0106B-TE2	MSLD030A E1LD0106B-TE2	NA				
8' X 18'	\$29,655	\$30,718	MHMD010A E1MD0085A-TA2	*MSMD017A E1MD0153A-TA2	NA	MSLD030A E1LD0106B-TE2	*MSMD030A E1MD0278A-TA22	NA				
8' X 19'	\$31,080	\$32,201	MHMD010A E1MD0085A-TA2	MSMD017A E1MD0153A-TA2	NA	MSLD030A E1LD0106B-TE2	*MSMD030A E1MD0278A-TA22	NA				
8' X 20'	\$31,998	\$33,154	MHMD010A E1MD0085A-TA2	MSMD017A E1MD0153A-TA2	NA	MSLD030A E1LD0106B-TE2	*MSMD030A E1MD0278A-TA22	NA				

Refrigeration sizing based on 100°F. ambient temperature on all surfaces, outdoor location, (1) 36" x 78" door, **no product load** and 10% safety factor added, 16 hour run time on coolers and 20 hour on freezers. Price includes outdoor membrane roof for outdoor models.

NOTES:

Doors can be located in any standard location on any compartment wall surfaces as shown on STANDARD DOOR LOCATION CHART on page 21. Specify hinging and location when ordering.

For Remote Refrigeration pricing, refer to pages 41-42.



Single Compartment Walk-Ins

LIST PRICING IS FOR PANELS ONLY. REFRIGERATION SYSTEMS MUST BE ADDED SEPARATELY.

INDOOR 9' WIDE MODELS

SIZE W X L	WITH FLOOR		REFRIGERATION SIZING WITH FLOOR						LESS FLOOR (UNINSULATED)				
	7' - 7"	8' - 7"	+35°F.			-10°F.			7' - 4"	8' - 4"	+35°F.		
	List	List	Normal	Heavy	Capsule Pak	Normal	Heavy	Capsule Pak	List	List	Normal	Heavy	Capsule Pak
9' X 9'	\$19,497	\$20,225	MHMD007AB E1MD0078A-TA2	MHMD007AB E1MD0078A-TA2	CPB075JC-S-4-EV	MSLD017A E1LD0076B-TE2	MSLD025A E1LD0106B-TE2	CPF150JC-S-4-EV	\$16,394	\$17,118	MHMD007AB E1MD0078A-TA2	*MHMD010A E1MD0085A-TA2	CPB075JC-S-4-EV
9' X 10'	\$20,190	\$20,958	MHMD007AB E1MD0078A-TA2	MHMD007AB E1MD0078A-TA2	CPB100JC-S-4-EV	MSLD017A E1LD0076B-TE2	MSLD025A E1LD0106B-TE2	CPF150JC-S-4-EV	\$16,831	\$17,590	MHMD007AB E1MD0078A-TA2	*MHMD010A E1MD0085A-TA2	CPB075JC-S-4-EV
9' X 11'	\$21,567	\$22,393	MHMD007AB E1MD0078A-TA2	MHMD007AB E1MD0078A-TA2	CPB100JC-S-4-EV	MSLD017A E1LD0076B-TE2	MSLD025A E1LD0106B-TE2	CPF150JC-S-4-EV	\$17,952	\$18,769	MHMD007AB E1MD0078A-TA2	*MSMD012A E1MD0109A-TA2	CPB075JC-S-4-EV
9' X 12'	\$22,459	\$23,320	MHMD007AB E1MD0078A-TA2	*MHMD010A E1MD0085A-TA2	CPB100JC-S-4-EV	*MSLD020A E1LD0088B-TE2	MSLD030A E1LD0106B-TE2	CPF200JC-S-4-EV	\$18,588	\$19,440	MHMD007AB E1MD0078A-TA2	MSMD012A E1MD0109A-TA2	CPB100JC-S-4-EV
9' X 13'	\$24,158	\$25,054	MHMD007AB E1MD0078A-TA2	*MHMD010A E1MD0085A-TA2	CPB100JC-S-4-EV	*MSLD025A E1LD0106B-TE2	MSLD030A E1LD0106B-TE2	CPF200JC-S-4-EV	\$19,577	\$20,468	*MHMD010A E1MD0085A-TA2	MSMD012A E1MD0109A-TA2	CPB100JC-S-4-EV
9' X 14'	\$24,851	\$25,787	MHMD007AB E1MD0078A-TA2	MHMD010A E1MD0085A-TA2	CPB100JC-S-4-EV	MSLD025A E1LD0106B-TE2	MSLD030A E1LD0106B-TE2	CPF200JC-S-4-EV	\$20,014	\$20,936	MHMD010A E1MD0085A-TA2	*MSMD012A E1MD0109A-TA2	CPB100JC-S-4-EV
9' X 15'	\$26,229	\$27,222	MHMD007AB E1MD0078A-TA2	MHMD010A E1MD0085A-TA2	NA	MSLD025A E1LD0106B-TE2	MSLD030A E1LD0106B-TE2	NA	\$21,091	\$22,075	MHMD010A E1MD0085A-TA2	*MSMD015A E1MD0136A-TA2	NA
9' X 16'	\$27,120	\$28,149	MHMD007AB E1MD0078A-TA2	*MSMD012A E1MD0109A-TA2	NA	MSLD025A E1LD0106B-TE2	MSLD035A E1LD0124TE2	NA	\$21,739	\$22,759	*MSMD012A E1MD0109A-TA2	*MSMD017A E1MD0153A-TA2	NA
9' X 17'	\$28,820	\$29,883	MHMD007AB E1MD0078A-TA2	MSMD012A E1MD0109A-TA2	NA	MSLD025A E1LD0106B-TE2	MSLD035A E1LD0124TE2	NA	\$22,719	\$23,774	MSMD012A E1MD0109A-TA2	MSMD017A E1MD0153A-TA2	NA
9' X 18'	\$29,513	\$30,616	MHMD007AB E1MD0078A-TA2	MSMD012A E1MD0109A-TA2	NA	MSLD025A E1LD0106B-TE2	MSLD035A E1LD0124TE2	NA	\$23,170	\$24,260	MSMD012A E1MD0109A-TA2	MSMD017A E1MD0153A-TA2	NA
9' X 19'	\$30,890	\$32,046	MHMD007AB E1MD0078A-TA2	MSMD012A E1MD0109A-TA2	NA	MSLD030A E1LD0106B-TE2	MSLD035A E1LD0124TE2	NA	\$24,260	\$25,412	MSMD012A E1MD0109A-TA2	*MSMD017A E1MD0153A-TA2	NA
9' X 20'	\$31,782	\$32,978	MHMD010A E1MD0085A-TA2	MSMD012A E1MD0109A-TA2	NA	MSLD030A E1LD0106B-TE2	MSLD035A E1LD0124TE2	NA	\$24,953	\$26,140	MSMD012A E1MD0109A-TA2	*MSMD020A E1MD0163A-TA2	NA

OUTDOOR 9' WIDE MODELS

SIZE W X L	WITH FLOOR		REFRIGERATION SIZING WITH FLOOR					
	7' - 7"	8' - 7"	+35°F.			-10°F.		
	List	List	Normal	Heavy	Capsule Pak	Normal	Heavy	Capsule Pak
9' X 9'	\$20,299	\$21,028	*MHMD007AB E1MD0078A-TA2	MHMD010A E1MD0085A-TA2	CPB100JC-E-4-EV	MSLD017A E1LD0076B-TE2	MSLD030A E1LD0106B-TE2	CPF150JC-E-4-EV
9' X 10'	\$21,082	\$21,850	MHMD007AB E1MD0078A-TA2	MHMD010A E1MD0085A-TA2	CPB100JC-E-4-EV	*MSLD020A E1LD0088B-TE2	MSLD030A E1LD0106B-TE2	CPF150JC-E-4-EV
9' X 11'	\$22,548	\$23,373	MHMD007AB E1MD0078A-TA2	*MSMD012A E1MD0109A-TA2	CPB100JC-E-4-EV	*MSLD025A E1LD0106B-TE2	MSLD030A E1LD0106B-TE2	CPF150JC-E-4-EV
9' X 12'	\$23,529	\$24,389	MHMD007AB E1MD0078A-TA2	MSMD012A E1MD0109A-TA2	CPB100JC-E-4-EV	MSLD025A E1LD0106B-TE2	MSLD030A E1LD0106B-TE2	CPF200JC-E-4-EV
9' X 13'	\$25,317	\$26,213	MHMD007AB E1MD0078A-TA2	MSMD012A E1MD0109A-TA2	CPB100JC-E-4-EV	MSLD025A E1LD0106B-TE2	MSLD030A E1LD0106B-TE2	CPF200JC-E-4-EV
9' X 14'	\$26,099	\$27,035	MHMD007AB E1MD0078A-TA2	*MSMD015A E1MD0136A-TA2	CPB100JC-E-4-EV	MSLD025A E1LD0106B-TE2	MSLD030A E1LD0106B-TE2	CPF200JC-E-4-EV
9' X 15'	\$27,566	\$28,559	*MHMD010A E1MD0085A-TA2	*MSMD015A E1MD0136A-TA2	NA	MSLD025A E1LD0106B-TE2	MSLD030A E1LD0106B-TE2	NA
9' X 16'	\$28,547	\$29,575	*MHMD010A E1MD0085A-TA2	*MSMD017A E1MD0153A-TA2	NA	MSLD030A E1LD0106B-TE2	MSLD035A E1LD0124TE2	NA
9' X 17'	\$30,335	\$31,399	MHMD010A E1MD0085A-TA2	*MSMD017A E1MD0153A-TA2	NA	MSLD030A E1LD0106B-TE2	MSLD035A E1LD0124TE2	NA
9' X 18'	\$31,117	\$32,221	MHMD010A E1MD0085A-TA2	MSMD017A E1MD0153A-TA2	NA	MSLD030A E1LD0106B-TE2	MSLD035A E1LD0124TE2	NA
9' X 19'	\$32,584	\$33,740	*MSMD012A E1MD0109A-TA2	MSMD017A E1MD0153A-TA2	NA	MSLD030A E1LD0106B-TE2	MSLD035A E1LD0124TE2	NA
9' X 20'	\$33,564	\$34,761	*MSMD012A E1MD0109A-TA2	*MSMD020A E1MD0163A-TA2	NA	MSLD030A E1LD0106B-TE2	MSLD035A E1LD0124TE2	NA

Refrigeration sizing based on 100°F. ambient temperature on all surfaces, outdoor location, (1) 36" x 78" door, **no product load** and 10% safety factor added, 16 hour run time on coolers and 20 hour on freezers. Price includes outdoor membrane roof for outdoor models.

NOTES:

Doors can be located in any standard location on any compartment wall surfaces as shown on STANDARD DOOR LOCATION CHART on page 21. Specify hinging and location when ordering.

For Remote Refrigeration pricing, refer to pages 41-42.



Single Compartment Walk-Ins

LIST PRICING IS FOR PANELS ONLY. REFRIGERATION SYSTEMS MUST BE ADDED SEPARATELY.

INDOOR 10' WIDE MODELS

SIZE W X L	WITH FLOOR		REFRIGERATION SIZING WITH FLOOR						LESS FLOOR (UNINSULATED)					
	7' - 7"	8' - 7"	+35°F.			-10°F.			7' - 4"	8' - 4"	+35°F.			
	List	List	Normal	Heavy	Capsule Pak	Normal	Heavy	Capsule Pak	List	List	Normal	Heavy	Capsule Pak	
10' X 10'	\$22,825	\$23,615	MHMD007AB E1MD0078A-TA2	MHMD007AB E1MD0078A-TA2	CPB100JC-S-4-EV	MSLD017A E1LD0076B-TE2	MSLD025A E1LD0106B-TE2	CPF200JC-S-4-EV	\$18,230	\$19,025	MHMD007AB E1MD0078A-TA2	*MSMD012A E1MD0109A-TA2	CPB075JC-S-4-EV	
10' X 11'	\$24,247	\$25,107	*MHMD007AB E1MD0078A-TA2	*MHMD010A E1MD0085A-TA2	CPB100JC-S-4-EV	*MSLD020A E1LD0088B-TE2	MSLD030A E1LD0106B-TE2	CPF200JC-S-4-EV	\$19,325	\$20,177	MHMD007AB E1MD0078A-TA2	MSMD012A E1MD0109A-TA2	CPB100JC-S-4-EV	
10' X 12'	\$25,077	\$25,977	*MHMD007AB E1MD0078A-TA2	MHMD010A E1MD0085A-TA2	CPB100JC-S-4-EV	*MSLD025A E1LD0106B-TE2	MSLD030A E1LD0106B-TE2	CPF200JC-S-4-EV	\$19,983	\$20,870	*MHMD010A E1MD0085A-TA2	MSMD012A E1MD0109A-TA2	CPB100JC-S-4-EV	
10' X 13'	\$27,456	\$28,387	MHMD007AB E1MD0078A-TA2	MHMD010A E1MD0085A-TA2	CPB100JC-S-4-EV	MSLD025A E1LD0106B-TE2	MSLD030A E1LD0106B-TE2	CPF200JC-S-4-EV	\$21,307	\$22,234	MHMD010A E1MD0085A-TA2	*MSMD015A E1MD0136A-TA2	CPB100JC-S-4-EV	
10' X 14'	\$28,197	\$29,164	MHMD007AB E1MD0078A-TA2	*MSMD012A E1MD0109A-TA2	CPB100JC-S-4-EV	MSLD025A E1LD0106B-TE2	MSLD030A E1LD0106B-TE2	CPF200JC-S-4-EV	\$21,748	\$22,706	MHMD010A E1MD0085A-TA2	*MSMD017A E1MD0153A-TA2	CPB100JC-S-4-EV	
10' X 15'	\$29,632	\$30,660	MHMD007AB E1MD0078A-TA2	*MSMD012A E1MD0109A-TA2	NA	MSLD025A E1LD0106B-TE2	MSLD035A E1LD0124TE2	NA	\$22,843	\$23,863	*MSMD012A E1MD0109A-TA2	MSMD017A E1MD0153A-TA2	NA	
10' X 16'	\$30,462	\$31,526	MHMD007AB E1MD0078A-TA2	MSMD012A E1MD0109A-TA2	NA	MSLD025A E1LD0106B-TE2	MSLD035A E1LD0124TE2	NA	\$23,457	\$24,511	MSMD012A E1MD0109A-TA2	MSMD017A E1MD0153A-TA2	NA	
10' X 17'	\$32,836	\$33,940	MHMD007AB E1MD0078A-TA2	MSMD012A E1MD0109A-TA2	NA	MSLD030A E1LD0106B-TE2	MSLD035A E1LD0124TE2	NA	\$24,768	\$25,858	MSMD012A E1MD0109A-TA2	MSMD017A E1MD0153A-TA2	NA	
10' X 18'	\$33,578	\$34,717	MHMD007AB E1MD0078A-TA2	MSMD012A E1MD0109A-TA2	NA	MSLD030A E1LD0106B-TE2	MSLD035A E1LD0124TE2	NA	\$25,235	\$26,365	MSMD012A E1MD0109A-TA2	*MSMD020A E1MD0163A-TA2	NA	
10' X 19'	\$35,013	\$36,209	*MHMD010A E1MD0085A-TA2	*MSMD015A E1MD0136A-TA2	NA	MSLD030A E1LD0106B-TE2	MSLD035A E1LD0124TE2	NA	\$26,348	\$27,535	*MSMD015A E1MD0136A-TA2	MSMD020A E1MD0163A-TA2	NA	
10' X 20'	\$35,847	\$37,074	*MHMD010A E1MD0085A-TA2	*MSMD016A E1MD0153A-TA2	NA	MSLD030A E1LD0106B-TE2	MSLD035A E1LD0124TE2	NA	\$26,961	\$28,184	*MSMD017A E1MD0153A-TA2	MSMD020A E1MD0163A-TA2	NA	

OUTDOOR 10' WIDE MODELS

SIZE W X L	WITH FLOOR		REFRIGERATION SIZING WITH FLOOR					
	7' - 7"	8' - 7"	+35°F.			-10°F.		
	List	List	Normal	Heavy	Capsule Pak	Normal	Heavy	Capsule Pak
10' X 10'	\$23,816	\$24,606	MHMD007AB E1MD0078A-TA2	*MSMD012A E1MD0109A-TA2	CPB100JC-E-4-EV	*MSLD025A E1LD0106B-TE2	*MSLD025A E1LD0106B-TE2	CPF200JC-E-4-EV
10' X 11'	\$25,336	\$26,197	MHMD007AB E1MD0078A-TA2	MSMD012A E1MD0109A-TA2	CPB100JC-E-4-EV	MSLD025A E1LD0106B-TE2	MSLD030A E1LD0106B-TE2	CPF200JC-E-4-EV
10' X 12'	\$26,265	\$27,166	MHMD007AB E1MD0078A-TA2	MSMD012A E1MD0109A-TA2	CPB100JC-E-4-EV	MSLD025A E1LD0106B-TE2	MSLD030A E1LD0106B-TE2	CPF200JC-E-4-EV
10' X 13'	\$28,743	\$29,675	MHMD007AB E1MD0078A-TA2	*MSMD015A E1MD0136A-TA2	CPB100JC-E-4-EV	MSLD025A E1LD0106B-TE2	MSLD030A E1LD0106B-TE2	CPF200JC-E-4-EV
10' X 14'	\$29,584	\$30,551	*MHMD010A E1MD0085A-TA2	*MSMD017A E1MD0153A-TA2	CPB100JC-E-4-EV	MSLD025A E1LD0106B-TE2	MSLD030A E1LD0106B-TE2	CPF200JC-E-4-EV
10' X 15'	\$31,118	\$32,146	MHMD010A E1MD0085A-TA2	*MSMD017A E1MD0153A-TA2	NA	MSLD030A E1LD0106B-TE2	MSLD030A E1LD0106B-TE2	NA
10' X 16'	\$32,047	\$33,110	MHMD010A E1MD0085A-TA2	MSMD017A E1MD0153A-TA2	NA	MSLD030A E1LD0106B-TE2	MSLD030A E1LD0106B-TE2	NA
10' X 17'	\$34,520	\$35,624	*MSMD012A E1MD0109A-TA2	MSMD017A E1MD0153A-TA2	NA	MSLD030A E1LD0106B-TE2	MSLD035A E1LD0124TE2	NA
10' X 18'	\$35,361	\$36,500	*MSMD012A E1MD0109A-TA2	MSMD017A E1MD0153A-TA2	NA	MSLD030A E1LD0106B-TE2	MSLD035A E1LD0124TE2	NA
10' X 19'	\$36,895	\$38,091	MSMD012A E1MD0109A-TA2	*MSMD020A E1MD0163A-TA2	NA	MSLD030A E1LD0106B-TE2	MSLD035A E1LD0124TE2	NA
10' X 20'	\$37,828	\$39,055	MSMD012A E1MD0109A-TA2	*MSMD020A E1MD0163A-TA2	NA	MSLD030A E1LD0106B-TE2	MSLD035A E1LD0124TE2	NA

Refrigeration sizing based on 100°F. ambient temperature on all surfaces, outdoor location, (1) 36" x 78" door, **no product load** and 10% safety factor added, 16 hour run time on coolers and 20 hour on freezers. Price includes outdoor membrane roof for outdoor models.

NOTES:

Doors can be located in any standard location on any compartment wall surfaces as shown on STANDARD DOOR LOCATION CHART on page 21. Specify hinging and location when ordering.

For Remote Refrigeration pricing, refer to pages 41-42.



Single Compartment Walk-Ins

LIST PRICING IS FOR PANELS ONLY. REFRIGERATION SYSTEMS MUST BE ADDED SEPARATELY.

SIZE W X L	WITH FLOOR		INDOOR 11' WIDE MODELS						LESS FLOOR (UNINSULATED)				
	7' - 7"	8' - 7"	REFRIGERATION SIZING WITH FLOOR			REFRIGERATION SIZING WITH FLOOR			7' - 4"	8' - 4"	REFRIGERATION SIZING WITH FLOOR		
	List	List	Normal	Heavy	Capsule Pak	Normal	Heavy	Capsule Pak	List	List	Normal	Heavy	Capsule Pak
11' X 11'	\$27,416	\$28,321	*MHMD007AB E1MD0078A-TA2	MHMD010A E1MD0085A-TA2	NA	*MSLD025A E1LD0106B-TE2	MSLD030A E1LD0106B-TE2	NA	\$21,422	\$22,331	*MHMD010A E1MD0085A-TA2	MSMD012A E1MD0109A-TA2	NA
11' X 12'	\$28,334	\$29,288	MHMD007AB E1MD0078A-TA2	MHMD010A E1MD0085A-TA2	NA	MSLD025A E1LD0106B-TE2	MSLD030A E1LD0106B-TE2	NA	\$22,115	\$23,059	MHMD010A E1MD0085A-TA2	*MSMD015A E1MD0136A-TA2	NA
11' X 13'	\$31,080	\$32,073	MHMD007AB E1MD0078A-TA2	*MSMD012A E1MD0109A-TA2	NA	MSLD025A E1LD0106B-TE2	MSLD030A E1LD0106B-TE2	NA	\$23,602	\$24,587	MHMD010A E1MD0085A-TA2	*MSMD017A E1MD0153A-TA2	NA
11' X 14'	\$31,795	\$32,823	MHMD007AB E1MD0078A-TA2	MSMD012A E1MD0109A-TA2	NA	MSLD025A E1LD0106B-TE2	MSLD030A E1LD0106B-TE2	NA	\$24,026	\$25,046	MSMD012A E1MD0109A-TA2	MSMD017A E1MD0153A-TA2	NA
11' X 15'	\$33,569	\$34,655	MHMD007AB E1MD0078A-TA2	MSMD012A E1MD0109A-TA2	NA	MSLD025A E1LD0106B-TE2	MSLD035A E1LD0124TE2	NA	\$25,350	\$26,427	MSMD012A E1MD0109A-TA2	MSMD017A E1MD0153A-TA2	NA
11' X 16'	\$34,514	\$35,622	MHMD007AB E1MD0078A-TA2	MSMD012A E1MD0109A-TA2	NA	MSLD030A E1LD0106B-TE2	MSLD035A E1LD0124TE2	NA	\$25,999	\$27,116	MSMD012A E1MD0109A-TA2	MSMD017A E1MD0153A-TA2	NA
11' X 17'	\$37,251	\$38,407	*MHMD010A E1MD0085A-TA2	*MSMD015A E1MD0136A-TA2	NA	MSLD030A E1LD0106B-TE2	MSLD035A E1LD0124TE2	NA	\$27,478	\$28,625	MSMD015A E1MD0136A-TA2	*MSMD020A E1MD0163A-TA2	NA
11' X 18'	\$37,966	\$39,162	*MHMD010A E1MD0085A-TA2	*MSMD015A E1MD0136A-TA2	NA	MSLD030A E1LD0106B-TE2	MSLD035A E1LD0124TE2	NA	\$27,928	\$29,115	MSMD015A E1MD0136A-TA2	*MSMD020A E1MD0163A-TA2	NA
11' X 19'	\$39,740	\$40,989	MHMD010A E1MD0085A-TA2	*MSMD017A E1MD0153A-TA2	NA	MSLD035A E1LD0124TE2	MSLD035A E1LD0124TE2	NA	\$29,270	\$30,515	*MSMD017A E1MD0153A-TA2	MSMD020A E1MD0163A-TA2	NA
11' X 20'	\$40,672	\$41,960	MHMD010A E1MD0085A-TA2	*MSMD017A E1MD0153A-TA2	NA	MSLD040A E1LD0178B-TE2	MSLD040A E1LD0178B-TE2	NA	\$29,919	\$31,199	MSMD017A E1MD0153A-TA2	MSMD020A E1MD0163A-TA2	NA

SIZE W X L	WITH FLOOR		OUTDOOR 11' WIDE MODELS					
	7' - 7"	8' - 7"	REFRIGERATION SIZING WITH FLOOR			REFRIGERATION SIZING WITH FLOOR		
	List	List	Normal	Heavy	Capsule Pak	Normal	Heavy	Capsule Pak
11' X 11'	\$28,615	\$29,519	MHMD007AB E1MD0078A-TA2	MSMD012A E1MD0109A-TA2	NA	MSLD025A E1LD0106B-TE2	MSLD030A E1LD0106B-TE2	NA
11' X 12'	\$29,642	\$30,595	MHMD007AB E1MD0078A-TA2	*MSMD015A E1MD0136A-TA2	NA	MSLD025A E1LD0106B-TE2	MSLD030A E1LD0106B-TE2	NA
11' X 13'	\$32,496	\$33,489	*MHMD010A E1MD0085A-TA2	*MSMD017A E1MD0153A-TA2	NA	MSLD025A E1LD0106B-TE2	MSLD035A E1LD0124TE2	NA
11' X 14'	\$33,320	\$34,349	MHMD010A E1MD0085A-TA2	*MSMD017A E1MD0153A-TA2	NA	MSLD025A E1LD0106B-TE2	MSLD035A E1LD0124TE2	NA
11' X 15'	\$35,204	\$36,289	MHMD010A E1MD0085A-TA2	MSMD017A E1MD0153A-TA2	NA	MSLD025A E1LD0106B-TE2	MSLD035A E1LD0124TE2	NA
11' X 16'	\$36,257	\$37,365	*MSMD012A E1MD0109A-TA2	MSMD017A E1MD0153A-TA2	NA	MSLD030A E1LD0106B-TE2	MSLD035A E1LD0124TE2	NA
11' X 17'	\$39,103	\$40,259	MSMD012A E1MD0109A-TA2	MSMD020A E1MD0163A-TA2	NA	MSLD030A E1LD0106B-TE2	MSLD035A E1LD0124TE2	NA
11' X 18'	\$39,927	\$41,123	MSMD012A E1MD0109A-TA2	MSMD020A E1MD0163A-TA2	NA	MSLD030A E1LD0106B-TE2	MSLD035A E1LD0124TE2	NA
11' X 19'	\$41,810	\$43,060	MSMD012A E1MD0109A-TA2	MSMD020A E1MD0163A-TA2	NA	MSLD035A E1LD0124TE2	MSLD035A E1LD0124TE2	NA
11' X 20'	\$42,851	\$44,140	MSMD012A E1MD0109A-TA2	MSMD020A E1MD0163A-TA2	NA	MSLD040A E1LD0178B-TE2	MSLD040A E1LD0178B-TE2	NA

Refrigeration sizing based on 100°F. ambient temperature on all surfaces, outdoor location, (1) 36" x 78" door, **no product load** and 10% safety factor added, 16 hour run time on coolers and 20 hour on freezers. Price includes outdoor membrane roof for outdoor models.

NOTES:

Doors can be located in any standard location on any compartment wall surfaces as shown on STANDARD DOOR LOCATION CHART on page 21. Specify hinging and location when ordering.

For Remote Refrigeration pricing, refer to pages 41-42.



Single Compartment Walk-Ins

LIST PRICING IS FOR PANELS ONLY. REFRIGERATION SYSTEMS MUST BE ADDED SEPARATELY.

INDOOR 12' WIDE MODELS

SIZE W X L	WITH FLOOR		REFRIGERATION SIZING WITH FLOOR						LESS FLOOR (UNINSULATED)					
	7' - 7"	8' - 7"	+35° F.			-10° F.			7' - 4"	8' - 4"	+35° F.			
	List	List	Normal	Heavy	Cap Pak	Normal	Heavy	Cap Pak	List	List	Normal	Heavy	Cap Pak	
12' X 12'	\$29,336	\$30,312	MHMD007AB E1MD0078A-TA2	*MSMD012A E1MD0109A-TA2	NA	MSLD025A E1LD0106B-TE2	MSLD030A E1LD0106B-TE2	NA	\$22,914	\$23,898	MHMD010A E1MD0085A-TA2	*MSMD017A E1MD0153A-TA2	NA	
12' X 13'	\$32,130	\$33,141	MHMD007AB E1MD0078A-TA2	MSMD012A E1MD0109A-TA2	NA	MSLD025A E1LD0106B-TE2	MSLD030A E1LD0106B-TE2	NA	\$24,419	\$25,438	MSMD012A E1MD0109A-TA2	MSMD017A E1MD0153A-TA2	NA	
12' X 14'	\$32,894	\$33,944	MHMD007AB E1MD0078A-TA2	MSMD012A E1MD0109A-TA2	NA	MSLD025A E1LD0106B-TE2	MSLD030A E1LD0106B-TE2	NA	\$24,860	\$25,915	MSMD012A E1MD0109A-TA2	MSMD017A E1MD0153A-TA2	NA	
12' X 15'	\$34,712	\$35,820	MHMD007AB E1MD0078A-TA2	MSMD012A E1MD0109A-TA2	NA	MSLD030A E1LD0106B-TE2	MSLD030A E1LD0106B-TE2	NA	\$26,198	\$27,314	MSMD012A E1MD0109A-TA2	*MSMD020A E1MD0136A-TA2	NA	
12' X 16'	\$35,692	\$36,836	*MHMD010A E1MD0085A-TA2	*MSMD015A E1MD0136A-TA2	NA	MSLD030A E1LD0106B-TE2	MSLD030A E1LD0106B-TE2	NA	\$26,873	\$28,021	*MSMD015A E1MD0136A-TA2	MSMD020A E1MD0136A-TA2	NA	
12' X 17'	\$38,487	\$39,670	MHMD010A E1MD0085A-TA2	MSMD015A E1MD0136A-TA2	NA	MSLD030A E1LD0106B-TE2	MSLD035A E1LD0124TE2	NA	\$28,361	\$29,548	MSMD012A E1MD0153A-TA2	MSMD020A E1MD0163A-TA2	NA	
12' X 18'	\$39,250	\$40,468	MHMD010A E1MD0085A-TA2	*MSMD017A E1MD0153A-TA2	NA	MSLD030A E1LD0106B-TE2	MSLD035A E1LD0124TE2	NA	\$28,833	\$30,056	MSMD017A E1MD0153A-TA2	MSMD020A E1MD0163A-TA2	NA	
12' X 19'	\$41,069	\$42,344	MHMD010A E1MD0085A-TA2	MSMD017A E1MD0153A-TA2	NA	MSLD035A E1LD0124TE2	MSLD040A E1LD0178B-TE2	NA	\$30,184	\$31,464	MSMD015A E1MD0153A-TA2	*MSMD025A E1MD0188A-TA2	NA	
12' X 20'	\$42,049	\$43,360	*MSMD012A E1MD0109A-TA2	MSMD017A E1MD0153A-TA2	NA	MSLD035A E1LD0124TE2	MSLD040A E1LD0178B-TE2	NA	\$30,859	\$32,174	MSMD017A E1MD0153A-TA2	*MSMD025A E1MD0188A-TA2	NA	

OUTDOOR 12' WIDE MODELS

SIZE W X L	WITH FLOOR		REFRIGERATION SIZING WITH FLOOR					
	7' - 7"	8' - 7"	+35° F.			-10° F.		
	List	List	Normal	Heavy	Cap Pak	Normal	Heavy	Cap Pak
12' X 12'	\$30,762	\$31,738	*MHMD010A E1MD0085A-TA2	*MSMD017A E1MD0153A-TA2	NA	MSLD025A E1LD0106B-TE2	MSLD030A E1LD0106B-TE2	NA
12' X 13'	\$33,675	\$34,686	MHMD010A E1MD0085A-TA2	MSMD017A E1MD0153A-TA2	NA	MSLD025A E1LD0106B-TE2	MSLD030A E1LD0106B-TE2	NA
12' X 14'	\$34,558	\$35,609	MHMD010A E1MD0085A-TA2	MSMD017A E1MD0153A-TA2	NA	MSLD030A E1LD0106B-TE2	MSLD035A E1LD0124-TE2	NA
12' X 15'	\$36,495	\$37,603	*MSMD012A E1MD0109A-TA2	MSMD017A E1MD0153A-TA2	NA	MSLD030A E1LD0106B-TE2	MSLD035A E1LD0124-TE2	NA
12' X 16'	\$37,594	\$38,737	MSMD012A E1MD0109A-TA2	*MSMD020A E1MD0163A-TA2	NA	MSLD030A E1LD0106B-TE2	MSLD035A E1LD0124-TE2	NA
12' X 17'	\$40,507	\$41,690	MSMD012A E1MD0109A-TA2	MSMD020A E1MD0163A-TA2	NA	MSLD030A E1LD0106B-TE2	MSLD035A E1LD0124-TE2	NA
12' X 18'	\$41,390	\$42,608	MSMD012A E1MD0109A-TA2	MSMD020A E1MD0163A-TA2	NA	MSLD035A E1LD0124- TE2	MSLD035A E1LD0124TE2	NA
12' X 19'	\$43,327	\$44,603	*MSMD015A E1MD0136A-TA2	MSMD020A E1MD0163A-TA2	NA	MSLD035A E1LD0124- TE2	MSLD040A E1LD0178B-TE2	NA
12' X 20'	\$44,426	\$45,737	*MSMD015A E1MD0136A-TA2	MSMD020A E1MD0163A-TA2	NA	MSLD035A E1LD0124- TE2	MSLD040A E1LD0178B-TE2	NA

Refrigeration sizing based on 100°F. ambient temperature on all surfaces, outdoor location, (1) 36" x 78" door, **no product load** and 10% safety factor added, 16 hour run time on coolers and 20 hour on freezers. Price includes outdoor membrane roof for outdoor models.

NOTES:

Doors can be located in any standard location on any compartment wall surfaces as shown on STANDARD DOOR LOCATION CHART on page 21. Specify hinging and location when ordering.

For Remote Refrigeration pricing, refer to pages 41-42.



Combination Walk-Ins

LIST PRICING IS FOR PANELS ONLY. REFRIGERATION SYSTEMS MUST BE ADDED SEPARATELY.

INDOOR 6' WIDE COMBINATION MODELS

"A" DIM.	"B" DIM.	"C" DIM.	"D" DIM.	WITH FLOOR				FLOORLESS			
				7' - 7"		8' - 7"		7' - 4"		8' - 4"	
				List	Wt.	List	Wt.	List	Wt.	List	Wt.
12'	6'	6'	*6'	\$23,527	1504	\$24,070	1635	Contact Factory	1257	Contact Factory	1389
14'	8'	6'	*6'	\$27,774	1675	\$28,436	1819	Contact Factory	1385	Contact Factory	1530
16'	8'	8'	*6'	\$29,221	1846	\$29,954	2003	Contact Factory	1513	Contact Factory	1670
18'	10'	8'	*6'	\$30,488	2018	\$31,296	2187	Contact Factory	1642	Contact Factory	1811
20'	10'	10'	*6'	\$31,596	2189	\$32,475	2371	Contact Factory	1770	Contact Factory	1952
22'	12'	10'	*6'	\$35,842	2360	\$36,836	2555	Contact Factory	1898	Contact Factory	2093
24'	12'	12'	*6'	\$37,290	2531	\$38,359	2739	Contact Factory	2026	Contact Factory	2234
26'	14'	12'	*6'	\$38,557	2703	\$39,700	2923	Contact Factory	2155	Contact Factory	2374
28'	14'	14'	*6'	\$39,665	2874	\$40,875	3106	Contact Factory	2283	Contact Factory	2515
30'	16'	14'	*6'	\$43,911	3045	\$45,240	3290	Contact Factory	2411	Contact Factory	2656
32'	16'	16'	*6'	\$45,359	3217	\$46,763	3474	Contact Factory	2539	Contact Factory	2797
34'	18'	16'	*6'	\$46,626	3388	\$48,100	3658	Contact Factory	2668	Contact Factory	2938
36'	18'	18'	*6'	\$47,734	3559	\$49,279	3842	Contact Factory	2796	Contact Factory	3078
38'	20'	18'	*6'	\$51,980	3731	\$53,640	4026	Contact Factory	2924	Contact Factory	3219
40'	20'	20'	*6'	\$53,428	3902	\$55,163	4210	Contact Factory	3052	Contact Factory	3360

OUTDOOR 6 FOOT WIDE COMBINATION MODELS

"A" DIM.	"B" DIM.	"C" DIM.	"D" DIM.	WITH FLOOR			
				7' - 7"		8' - 7"	
				List	Wt.	List	Wt.
12'	6'	6'	*6'	\$24,240	1540	\$24,783	1617
14'	8'	6'	*6'	\$28,606	1717	\$29,268	1861
16'	8'	8'	*6'	\$30,172	1894	\$30,905	2051
18'	10'	8'	*6'	\$31,558	2072	\$32,366	2241
20'	10'	10'	*6'	\$32,785	2249	\$33,663	2431
22'	12'	10'	*6'	\$37,150	2426	\$38,143	2621
24'	12'	12'	*6'	\$38,717	2603	\$39,785	2811
26'	14'	12'	*6'	\$40,102	2781	\$41,246	3001
28'	14'	14'	*6'	\$41,329	2958	\$42,539	3190
30'	16'	14'	*6'	\$45,694	3135	\$47,023	3380
32'	16'	16'	*6'	\$47,261	3313	\$48,665	3570
34'	18'	16'	*6'	\$48,647	3490	\$50,121	3760
36'	18'	18'	*6'	\$49,874	3667	\$51,419	3950
38'	20'	18'	*6'	\$54,239	3845	\$55,899	4140
40'	20'	20'	*6'	\$55,806	4022	\$57,540	4330

Refrigeration sizing based on 100°F. ambient temperature on all surfaces, outdoor location, (1) 36" x 78" door, **no product load** and 10% safety factor added, 16 hour run time on coolers and 20 hour on freezers. Price includes outdoor membrane roof for outdoor models.

NOTES:

Doors can be located in any standard location on any compartment wall surfaces as shown on STANDARD DOOR LOCATION CHART on page 21. Specify hinging and location when ordering.

For Remote Refrigeration pricing, refer to pages 41-42.



Combination Walk-Ins

LIST PRICING IS FOR PANELS ONLY. REFRIGERATION SYSTEMS MUST BE ADDED SEPARATELY.

INDOOR 7 FOOT WIDE COMBINATION MODELS

"A" DIM.	"B" DIM.	"C" DIM.	"D" DIM.	WITH FLOOR				FLOORLESS			
				7' - 7"		8' - 7"		7' - 4"		8' - 4"	
				List	Wt.	List	Wt.	List	Wt.	List	Wt.
12'	6'	6'	*7'	\$25,540	1653	\$26,171	1794	Contact Factory	1363	Contact Factory	1504
14'	8'	6'	*7'	\$29,928	1838	\$30,674	1992	Contact Factory	1497	Contact Factory	1651
16'	8'	8'	*7'	\$31,521	2023	\$32,342	2190	Contact Factory	1632	Contact Factory	1798
18'	10'	8'	*7'	\$32,867	2209	\$33,759	2388	Contact Factory	1766	Contact Factory	1945
20'	10'	10'	*7'	\$34,064	2394	\$35,030	2585	Contact Factory	1901	Contact Factory	2092
22'	12'	10'	*7'	\$38,447	2579	\$39,533	2783	Contact Factory	2035	Contact Factory	2239
24'	12'	12'	*7'	\$40,045	2764	\$41,197	2981	Contact Factory	2170	Contact Factory	2386
26'	14'	12'	*7'	\$41,387	2949	\$42,614	3179	Contact Factory	2304	Contact Factory	2533
28'	14'	14'	*7'	\$42,583	3135	\$43,885	3376	Contact Factory	2439	Contact Factory	2680
30'	16'	14'	*7'	\$46,970	3320	\$48,387	3574	Contact Factory	2573	Contact Factory	2828
32'	16'	16'	*7'	\$48,564	3505	\$50,051	3772	Contact Factory	2708	Contact Factory	2975
34'	18'	16'	*7'	\$49,910	3690	\$51,473	3970	Contact Factory	2842	Contact Factory	3122
36'	18'	18'	*7'	\$51,106	3876	\$52,740	4168	Contact Factory	2977	Contact Factory	3269
38'	20'	18'	*7'	\$55,490	4061	\$57,242	4365	Contact Factory	3111	Contact Factory	3416
40'	20'	20'	*7'	\$57,088	4246	\$58,911	4563	Contact Factory	3246	Contact Factory	3563

OUTDOOR 7 FOOT WIDE COMBINATION MODELS

"A" DIM.	"B" DIM.	"C" DIM.	"D" DIM.	WITH FLOOR			
				7' - 7"		8' - 7"	
				List	Wt.	List	Wt.
12'	6'	6'	*7'	\$26,372	1695	\$27,003	1836
14'	8'	6'	*7'	\$30,898	1887	\$31,644	2041
16'	8'	8'	*7'	\$32,630	2079	\$33,451	2246
18'	10'	8'	*7'	\$34,115	2272	\$35,007	2451
20'	10'	10'	*7'	\$35,450	2464	\$36,417	2655
22'	12'	10'	*7'	\$39,972	2656	\$41,058	2860
24'	12'	12'	*7'	\$41,709	2848	\$42,861	3065
26'	14'	12'	*7'	\$43,189	3040	\$44,416	3270
28'	14'	14'	*7'	\$44,524	3233	\$45,826	3474
30'	16'	14'	*7'	\$49,051	3425	\$50,467	3679
32'	16'	16'	*7'	\$50,783	3617	\$52,270	3884
34'	18'	16'	*7'	\$52,268	3809	\$53,830	4089
36'	18'	18'	*7'	\$53,603	4002	\$55,236	4294
38'	20'	18'	*7'	\$58,124	4194	\$59,877	4498
40'	20'	20'	*7'	\$59,861	4386	\$61,684	4703

Refrigeration sizing based on 100°F. ambient temperature on all surfaces, outdoor location, (1) 36" x 78" door, **no product load** and 10% safety factor added, 16 hour run time on coolers and 20 hour on freezers. Price includes outdoor membrane roof for outdoor models.

NOTES:

Doors can be located in any standard location on any compartment wall surfaces as shown on STANDARD DOOR LOCATION CHART on page 21. Specify hinging and location when ordering.

For Remote Refrigeration pricing, refer to pages 41-42.



Combination Walk-Ins

LIST PRICING IS FOR PANELS ONLY. REFRIGERATION SYSTEMS MUST BE ADDED SEPARATELY.

INDOOR 8 FOOT WIDE COMBINATION MODELS

"A" DIM.	"B" DIM.	"C" DIM.	"D" DIM.	WITH FLOOR				FLOORLESS			
				7' - 7"		8' - 7"		7' - 4"		8' - 4"	
				List	Wt.	List	Wt.	List	Wt.	List	Wt.
12'	6'	6'	*8'	\$27,244	1802	\$27,954	1953	Contact Factory	1468	Contact Factory	1619
14'	8'	6'	*8'	\$31,742	2001	\$32,563	2165	Contact Factory	1609	Contact Factory	1772
16'	8'	8'	*8'	\$33,379	2200	\$34,275	2376	Contact Factory	1750	Contact Factory	1926
18'	10'	8'	*8'	\$34,858	2400	\$35,829	2588	Contact Factory	1891	Contact Factory	2079
20'	10'	10'	*8'	\$36,138	2599	\$37,180	2800	Contact Factory	2031	Contact Factory	2232
22'	12'	10'	*8'	\$40,632	2798	\$41,793	3011	Contact Factory	2172	Contact Factory	2386
24'	12'	12'	*8'	\$42,269	2997	\$43,501	3223	Contact Factory	2313	Contact Factory	2539
26'	14'	12'	*8'	\$43,753	3196	\$45,055	3435	Contact Factory	2454	Contact Factory	2692
28'	14'	14'	*8'	\$45,028	3395	\$50,820	3646	Contact Factory	2595	Contact Factory	2846
30'	16'	14'	*8'	\$49,526	3594	\$51,018	3858	Contact Factory	2735	Contact Factory	2999
32'	16'	16'	*8'	\$51,164	3793	\$52,726	4070	Contact Factory	2876	Contact Factory	3152
34'	18'	16'	*8'	\$52,643	3993	\$54,285	4281	Contact Factory	3017	Contact Factory	3306
36'	18'	18'	*8'	\$53,923	4192	\$55,631	4493	Contact Factory	3158	Contact Factory	3459
38'	20'	18'	*8'	\$58,416	4391	\$60,244	4705	Contact Factory	3299	Contact Factory	3613
40'	20'	20'	*8'	\$60,054	4590	\$61,956	4916	Contact Factory	3439	Contact Factory	3766

OUTDOOR 8 FOOT WIDE COMBINATION MODELS

"A" DIM.	"B" DIM.	"C" DIM.	"D" DIM.	WITH FLOOR			
				7' - 7"		8' - 7"	
				List	Wt.	List	Wt.
12'	6'	6'	*8'	\$28,195	1850	\$28,905	2001
14'	8'	6'	*8'	\$32,851	2057	\$33,672	2221
16'	8'	8'	*8'	\$34,647	2264	\$35,543	2440
18'	10'	8'	*8'	\$36,285	2472	\$37,256	2660
20'	10'	10'	*8'	\$37,723	2679	\$38,765	2880
22'	12'	10'	*8'	\$42,375	2886	\$43,536	3099
24'	12'	12'	*8'	\$44,171	3093	\$45,403	3319
26'	14'	12'	*8'	\$45,813	3300	\$47,115	3539
28'	14'	14'	*8'	\$47,247	3507	\$53,038	3758
30'	16'	14'	*8'	\$51,903	3714	\$53,395	3978
32'	16'	16'	*8'	\$53,700	3921	\$55,262	4198
34'	18'	16'	*8'	\$55,337	4129	\$56,979	4417
36'	18'	18'	*8'	\$56,775	4336	\$58,484	4637
38'	20'	18'	*8'	\$61,427	4543	\$63,255	4857
40'	20'	20'	*8'	\$63,224	4750	\$65,126	5076

Refrigeration sizing based on 100°F. ambient temperature on all surfaces, outdoor location, (1) 36" x 78" door, **no product load** and 10% safety factor added, 16 hour run time on coolers and 20 hour on freezers. Price includes outdoor membrane roof for outdoor models.

NOTES:

Doors can be located in any standard location on any compartment wall surfaces as shown on STANDARD DOOR LOCATION CHART on page 21. Specify hinging and location when ordering.

For Remote Refrigeration pricing, refer to pages 41-42.



Combination Walk-Ins

LIST PRICING IS FOR PANELS ONLY. REFRIGERATION SYSTEMS MUST BE ADDED SEPARATELY.

INDOOR 9 FOOT WIDE COMBINATION MODELS											
"A" DIM.	"B" DIM.	"C" DIM.	"D" DIM.	WITH FLOOR				FLOORLESS			
				7' - 7"		8' - 7"		7' - 4"		8' - 4"	
				List	Wt.	List	Wt.	List	Wt.	List	Wt.
12'	6'	6'	*9'	\$27,844	1952	\$28,586	2112	Contact Factory	1574	Contact Factory	1734
14'	8'	6'	*9'	\$32,448	2165	\$33,304	2337	Contact Factory	1721	Contact Factory	1894
16'	8'	8'	*9'	\$34,236	2378	\$35,163	2563	Contact Factory	1868	Contact Factory	2053
18'	10'	8'	*9'	\$35,781	2591	\$36,783	2788	Contact Factory	2015	Contact Factory	2213
20'	10'	10'	*9'	\$37,167	2804	\$38,239	3014	Contact Factory	2162	Contact Factory	2372
22'	12'	10'	*9'	\$41,771	3017	\$42,962	3240	Contact Factory	2309	Contact Factory	2532
24'	12'	12'	*9'	\$43,558	3230	\$44,821	3465	Contact Factory	2456	Contact Factory	2692
26'	14'	12'	*9'	\$45,103	3443	\$46,441	3691	Contact Factory	2603	Contact Factory	2851
28'	14'	14'	*9'	\$46,489	3656	\$47,897	3916	Contact Factory	2750	Contact Factory	3011
30'	16'	14'	*9'	\$51,098	3869	\$52,620	4142	Contact Factory	2897	Contact Factory	3171
32'	16'	16'	*9'	\$52,881	4082	\$54,479	4367	Contact Factory	3045	Contact Factory	3330
34'	18'	16'	*9'	\$54,426	4295	\$56,099	4593	Contact Factory	3192	Contact Factory	3490
36'	18'	18'	*9'	\$55,816	4508	\$57,555	4819	Contact Factory	3339	Contact Factory	3650
38'	20'	18'	*9'	\$60,420	4721	\$62,279	5044	Contact Factory	3486	Contact Factory	3809
40'	20'	20'	*9'	\$62,208	4934	\$64,137	5270	Contact Factory	3633	Contact Factory	3969

OUTDOOR 9 FOOT WIDE COMBINATION MODELS											
"A" DIM.	"B" DIM.	"C" DIM.	"D" DIM.	WITH FLOOR							
				7' - 7"		8' - 7"					
				List	Wt.	List	Wt.				
12'	6'	6'	*9'	\$28,914	2006	\$29,655	2166				
14'	8'	6'	*9'	\$33,696	2228	\$34,552	2400				
16'	8'	8'	*9'	\$35,662	2450	\$36,589	2635				
18'	10'	8'	*9'	\$37,385	2672	\$38,387	2869				
20'	10'	10'	*9'	\$38,950	2894	\$40,022	3104				
22'	12'	10'	*9'	\$43,732	3116	\$44,924	3339				
24'	12'	12'	*9'	\$45,698	3338	\$46,960	3573				
26'	14'	12'	*9'	\$47,421	3560	\$48,759	3808				
28'	14'	14'	*9'	\$48,985	3782	\$50,394	4042				
30'	16'	14'	*9'	\$53,772	4004	\$55,295	4277				
32'	16'	16'	*9'	\$55,734	4226	\$57,332	4511				
34'	18'	16'	*9'	\$57,457	4448	\$59,130	4746				
36'	18'	18'	*9'	\$59,026	4670	\$60,765	4981				
38'	20'	18'	*9'	\$63,808	4892	\$65,666	5215				
40'	20'	20'	*9'	\$65,774	5114	\$67,703	5450				

Refrigeration sizing based on 100°F. ambient temperature on all surfaces, outdoor location, (1) 36" x 78" door, **no product load** and 10% safety factor added, 16 hour run time on coolers and 20 hour on freezers. Price includes outdoor membrane roof for outdoor models.

NOTES:

Doors can be located in any standard location on any compartment wall surfaces as shown on STANDARD DOOR LOCATION CHART on page 21. Specify hinging and location when ordering.

For Remote Refrigeration pricing, refer to pages 41-42.



Combination Walk-Ins

LIST PRICING IS FOR PANELS ONLY. REFRIGERATION SYSTEMS MUST BE ADDED SEPARATELY.

INDOOR 10 FOOT WIDE COMBINATION MODELS

"A" DIM.	"B" DIM.	"C" DIM.	"D" DIM.	WITH FLOOR				FLOORLESS			
				7' - 7"		8' - 7"		7' - 4"		8' - 4"	
				List	Wt.	List	Wt.	List	Wt.	List	Wt.
12'	6'	6'	*10'	\$31,375	2101	\$32,192	2270	Contact Factory	1679	Contact Factory	1849
14'	8'	6'	*10'	\$37,334	2328	\$38,266	2510	Contact Factory	1833	Contact Factory	2015
16'	8'	8'	*10'	\$39,215	2555	\$40,221	2749	Contact Factory	1986	Contact Factory	2181
18'	10'	8'	*10'	\$40,879	2782	\$41,956	2989	Contact Factory	2139	Contact Factory	2347
20'	10'	10'	*10'	\$42,141	3009	\$43,293	3228	Contact Factory	2293	Contact Factory	2513
22'	12'	10'	*10'	\$48,100	3235	\$49,367	3468	Contact Factory	2446	Contact Factory	2679
24'	12'	12'	*10'	\$49,981	3462	\$51,323	3707	Contact Factory	2600	Contact Factory	2844
26'	14'	12'	*10'	\$51,645	3689	\$53,057	3947	Contact Factory	2753	Contact Factory	3010
28'	14'	14'	*10'	\$52,907	3916	\$54,391	4186	Contact Factory	2906	Contact Factory	3176
30'	16'	14'	*10'	\$58,866	4143	\$60,469	4426	Contact Factory	3060	Contact Factory	3342
32'	16'	16'	*10'	\$60,747	4370	\$62,420	4665	Contact Factory	3213	Contact Factory	3508
34'	18'	16'	*10'	\$62,411	4597	\$64,159	4905	Contact Factory	3408	Contact Factory	3674
36'	18'	18'	*10'	\$63,673	4824	\$65,492	5144	Contact Factory	3520	Contact Factory	3840
38'	20'	18'	*10'	\$69,632	5051	\$71,570	5384	Contact Factory	3673	Contact Factory	4006
40'	20'	20'	*10'	\$71,513	5278	\$73,521	5623	Contact Factory	3826	Contact Factory	4172

OUTDOOR 10 FOOT WIDE COMBINATION MODELS

"A" DIM.	"B" DIM.	"C" DIM.	"D" DIM.	WITH FLOOR			
				7' - 7"		8' - 7"	
				List	Wt.	List	Wt.
12'	6'	6'	*10'	\$32,564	2161	\$33,381	2330
14'	8'	6'	*10'	\$38,721	2398	\$39,653	2580
16'	8'	8'	*10'	\$40,800	2635	\$41,806	2829
18'	10'	8'	*10'	\$42,662	2872	\$43,739	3079
20'	10'	10'	*10'	\$44,122	3109	\$45,275	3328
22'	12'	10'	*10'	\$50,280	3345	\$51,546	3578
24'	12'	12'	*10'	\$52,358	3582	\$53,700	3827
26'	14'	12'	*10'	\$54,220	3819	\$55,633	4077
28'	14'	14'	*10'	\$55,681	4056	\$57,164	4326
30'	16'	14'	*10'	\$61,838	4293	\$63,440	4576
32'	16'	16'	*10'	\$63,917	4530	\$65,589	4825
34'	18'	16'	*10'	\$65,779	4767	\$67,527	5075
36'	18'	18'	*10'	\$67,239	5004	\$69,058	5324
38'	20'	18'	*10'	\$73,396	5241	\$75,334	5574
40'	20'	20'	*10'	\$75,475	5478	\$77,483	5823

Refrigeration sizing based on 100°F. ambient temperature on all surfaces, outdoor location, (1) 36" x 78" door, **no product load** and 10% safety factor added, 16 hour run time on coolers and 20 hour on freezers. Price includes outdoor membrane roof for outdoor models.

NOTES:

Doors can be located in any standard location on any compartment wall surfaces as shown on STANDARD DOOR LOCATION CHART on page 21. Specify hinging and location when ordering.

For Remote Refrigeration pricing, refer to pages 41-42.



Combination Walk-Ins

LIST PRICING IS FOR PANELS ONLY. REFRIGERATION SYSTEMS MUST BE ADDED SEPARATELY.

INDOOR 11 FOOT WIDE COMBINATION MODELS

"A" DIM.	"B" DIM.	"C" DIM.	"D" DIM.	WITH FLOOR				FLOORLESS			
				7' - 7"		8' - 7"		7' - 4"		8' - 4"	
				List	Wt.	List	Wt.	List	Wt.	List	Wt.
12'	6'	6'	*11'	\$34,456	2250	\$35,335	2429	Contact Factory	1785	Contact Factory	1964
14'	8'	6'	*11'	\$41,157	2491	\$42,159	2683	Contact Factory	1945	Contact Factory	2136
16'	8'	8'	*11'	\$42,989	2732	\$44,062	2936	Contact Factory	2104	Contact Factory	2308
18'	10'	8'	*11'	\$45,328	2973	\$46,472	3189	Contact Factory	2264	Contact Factory	2481
20'	10'	10'	*11'	\$46,794	3214	\$48,012	3443	Contact Factory	2424	Contact Factory	2653
22'	12'	10'	*11'	\$53,499	3454	\$54,836	3696	Contact Factory	2583	Contact Factory	2825
24'	12'	12'	*11'	\$55,326	3695	\$56,734	3949	Contact Factory	2743	Contact Factory	2997
26'	14'	12'	*11'	\$57,670	3936	\$59,145	4203	Contact Factory	2902	Contact Factory	3169
28'	14'	14'	*11'	\$59,136	4177	\$60,685	4456	Contact Factory	3062	Contact Factory	3342
30'	16'	14'	*11'	\$65,836	4418	\$67,500	4710	Contact Factory	3222	Contact Factory	3514
32'	16'	16'	*11'	\$67,668	4658	\$69,407	4963	Contact Factory	3381	Contact Factory	3686
34'	18'	16'	*11'	\$70,008	4899	\$71,817	5216	Contact Factory	3541	Contact Factory	3858
36'	18'	18'	*11'	\$71,473	5140	\$73,358	5470	Contact Factory	3701	Contact Factory	4030
38'	20'	18'	*11'	\$78,174	5381	\$80,173	5723	Contact Factory	3860	Contact Factory	4203
40'	20'	20'	*11'	\$80,006	5622	\$82,080	5977	Contact Factory	4020	Contact Factory	4375

OUTDOOR 11 FOOT WIDE COMBINATION MODELS

"A" DIM.	"B" DIM.	"C" DIM.	"D" DIM.	WITH FLOOR			
				7' - 7"		8' - 7"	
				List	Wt.	List	Wt.
12'	6'	6'	*11'	\$35,764	2316	\$36,642	2495
14'	8'	6'	*11'	\$42,682	2568	\$43,684	2760
16'	8'	8'	*11'	\$44,732	2820	\$45,805	3024
18'	10'	8'	*11'	\$47,290	3072	\$48,433	3288
20'	10'	10'	*11'	\$48,973	3324	\$50,191	3553
22'	12'	10'	*11'	\$55,896	3575	\$57,233	3817
24'	12'	12'	*11'	\$57,941	3827	\$59,349	4081
26'	14'	12'	*11'	\$60,503	4079	\$61,977	4346
28'	14'	14'	*11'	\$62,187	4331	\$63,736	4610
30'	16'	14'	*11'	\$69,105	4583	\$70,769	4875
32'	16'	16'	*11'	\$71,155	4834	\$72,894	5139
34'	18'	16'	*11'	\$73,712	5086	\$75,522	5403
36'	18'	18'	*11'	\$75,396	5338	\$77,280	5668
38'	20'	18'	*11'	\$82,314	5590	\$84,314	5932
40'	20'	20'	*11'	\$84,364	5842	\$86,438	6197

Refrigeration sizing based on 100°F. ambient temperature on all surfaces, outdoor location, (1) 36" x 78" door, **no product load** and 10% safety factor added, 16 hour run time on coolers and 20 hour on freezers. Price includes outdoor membrane roof for outdoor models.

NOTES:

Doors can be located in any standard location on any compartment wall surfaces as shown on STANDARD DOOR LOCATION CHART on page 21. Specify hinging and location when ordering.

For Remote Refrigeration pricing, refer to pages 41-42.



Combination Walk-Ins

LIST PRICING IS FOR PANELS ONLY. REFRIGERATION SYSTEMS MUST BE ADDED SEPARATELY.

INDOOR 12 FOOT WIDE COMBINATION MODELS

"A" DIM.	"B" DIM.	"C" DIM.	"D" DIM.	WITH FLOOR				FLOORLESS			
				7' - 7"		8' - 7"		7' - 4"		8' - 4"	
				List	Wt.	List	Wt.	List	Wt.	List	Wt.
12'	6'	6'	*12'	\$35,586	2400	\$36,522	2588	Contact Factory	1891	Contact Factory	2079
14'	8'	6'	*12'	\$42,380	2654	\$43,435	2855	Contact Factory	2056	Contact Factory	2257
16'	8'	8'	*12'	\$44,309	2909	\$45,434	3123	Contact Factory	2222	Contact Factory	2436
18'	10'	8'	*12'	\$46,736	3164	\$47,937	3390	Contact Factory	2388	Contact Factory	2614
20'	10'	10'	*12'	\$48,299	3418	\$49,570	3657	Contact Factory	2554	Contact Factory	2793
22'	12'	10'	*12'	\$55,097	3673	\$56,483	3924	Contact Factory	2720	Contact Factory	2971
24'	12'	12'	*12'	\$57,026	3928	\$58,482	4192	Contact Factory	2886	Contact Factory	3150
26'	14'	12'	*12'	\$59,454	4183	\$60,985	4459	Contact Factory	3052	Contact Factory	3328
28'	14'	14'	*12'	\$61,016	4437	\$62,618	4726	Contact Factory	3218	Contact Factory	3507
30'	16'	14'	*12'	\$67,809	4692	\$69,531	4993	Contact Factory	3384	Contact Factory	3685
32'	16'	16'	*12'	\$69,738	4947	\$71,535	5261	Contact Factory	3550	Contact Factory	3864
34'	18'	16'	*12'	\$72,166	5201	\$74,033	5528	Contact Factory	3716	Contact Factory	4042
36'	18'	18'	*12'	\$73,733	5456	\$75,671	5795	Contact Factory	3882	Contact Factory	4221
38'	20'	18'	*12'	\$80,526	5711	\$82,579	6063	Contact Factory	4048	Contact Factory	4399
40'	20'	20'	*12'	\$82,455	5966	\$84,583	6330	Contact Factory	4213	Contact Factory	4578

OUTDOOR 12 FOOT WIDE COMBINATION MODELS

"A" DIM.	"B" DIM.	"C" DIM.	"D" DIM.	WITH FLOOR			
				7' - 7"		8' - 7"	
				List	Wt.	List	Wt.
12'	6'	6'	*12'	\$37,013	2472	\$37,949	2660
14'	8'	6'	*12'	\$44,044	2738	\$45,099	2939
16'	8'	8'	*12'	\$46,211	3005	\$47,336	3219
18'	10'	8'	*12'	\$48,876	3272	\$50,077	3498
20'	10'	10'	*12'	\$50,676	3538	\$51,948	3777
22'	12'	10'	*12'	\$57,712	3805	\$59,098	4056
24'	12'	12'	*12'	\$59,878	4072	\$61,335	4336
26'	14'	12'	*12'	\$62,544	4339	\$64,076	4615
28'	14'	14'	*12'	\$64,344	4605	\$65,947	4894
30'	16'	14'	*12'	\$71,375	4872	\$73,097	5173
32'	16'	16'	*12'	\$73,542	5139	\$75,339	5453
34'	18'	16'	*12'	\$76,207	5405	\$78,075	5732
36'	18'	18'	*12'	\$78,012	5672	\$79,950	6011
38'	20'	18'	*12'	\$85,043	5939	\$87,096	6291
40'	20'	20'	*12'	\$87,210	6206	\$89,337	6570

Refrigeration sizing based on 100°F. ambient temperature on all surfaces, outdoor location, (1) 36" x 78" door, **no product load** and 10% safety factor added, 16 hour run time on coolers and 20 hour on freezers. Price includes outdoor membrane roof for outdoor models.

NOTES:

Doors can be located in any standard location on any compartment wall surfaces as shown on STANDARD DOOR LOCATION CHART on page 21. Specify hinging and location when ordering.

For Remote Refrigeration pricing, refer to pages 41-42.

Floor/Floorless Combination Indoor Walk-Ins

LIST PRICING IS FOR PANELS ONLY. REFRIGERATION SYSTEMS MUST BE ADDED SEPARATELY.

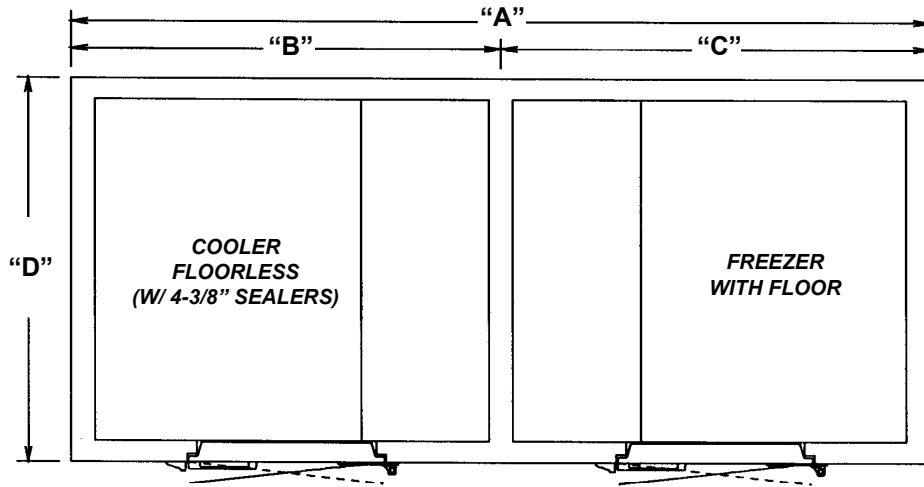

INDOOR 6 FOOT WIDE COMBINATION MODELS

"A" DIM.	"B" DIM.	"C" DIM.	"D" DIM.	COMBINATION WALK-IN			
				7' - 7"		8' - 7"	
				List	Wt.	List	Wt.
12'	6'	6'	*6'	\$24,136	1391	\$24,966	1523
14'	8'	6'	*6'	\$27,725	1522	\$28,670	1666
16'	8'	8'	*6'	\$29,023	1693	\$30,042	1850
18'	10'	8'	*6'	\$30,082	1824	\$31,172	1994
20'	10'	10'	*6'	\$31,031	1995	\$32,192	2177
22'	12'	10'	*6'	\$34,646	2126	\$35,922	2321
24'	12'	12'	*6'	\$35,926	2298	\$37,277	2505
26'	14'	12'	*6'	\$37,511	2429	\$38,932	2648
28'	14'	14'	*6'	\$38,473	2600	\$39,965	2832
30'	16'	14'	*6'	\$42,296	2731	\$43,673	2976
32'	16'	16'	*6'	\$43,594	2902	\$45,041	3160
34'	18'	16'	*6'	\$44,653	3033	\$46,171	3303
36'	18'	18'	*6'	\$45,602	3205	\$47,191	3487
38'	20'	18'	*6'	\$49,217	3336	\$50,925	3631
40'	20'	20'	*6'	\$50,497	3507	\$52,281	3815

Refrigeration sizing based on 100°F. ambient temperature on all surfaces, outdoor location, (1) 36" x 78" door, **no product load** and 10% safety factor added, 16 hour run time on coolers and 20 hour on freezers. Price includes outdoor membrane roof for outdoor models.

NOTES:

Doors can be located in any standard location on any compartment wall surfaces as shown on STANDARD DOOR LOCATION CHART on page 21. Specify hinging and location when ordering.

For Remote Refrigeration pricing, refer to pages 41-42.



Floor/Floorless Combination Indoor Walk-Ins

LIST PRICING IS FOR PANELS ONLY. REFRIGERATION SYSTEMS MUST BE ADDED SEPARATELY.

INDOOR 7 FOOT WIDE COMBINATION MODELS

"A" DIM.	"B" DIM.	"C" DIM.	"D" DIM.	COMBINATION WALK-IN			
				7' - 7"		8' - 7"	
				List	Wt.	List	Wt.
12'	6'	6'	*7'	\$26,198	1519	\$26,873	1660
14'	8'	6'	*7'	\$29,888	1656	\$30,682	1810
16'	8'	8'	*7'	\$31,287	1841	\$32,152	2007
18'	10'	8'	*7'	\$32,399	1978	\$33,340	2157
20'	10'	10'	*7'	\$33,401	2164	\$34,412	2355
22'	12'	10'	*7'	\$37,118	2301	\$38,244	2505
24'	12'	12'	*7'	\$38,504	2486	\$39,705	2703
26'	14'	12'	*7'	\$40,142	2623	\$41,413	2853
28'	14'	14'	*7'	\$41,157	2809	\$42,499	3050
30'	16'	14'	*7'	\$44,847	2946	\$46,308	3200
32'	16'	16'	*7'	\$46,247	3131	\$47,783	3398
34'	18'	16'	*7'	\$47,359	3268	\$48,966	3548
36'	18'	18'	*7'	\$48,361	3454	\$50,038	3746
38'	20'	18'	*7'	\$52,078	3591	\$53,874	3895
40'	20'	20'	*7'	\$53,464	3776	\$55,331	4093

INDOOR 8 FOOT WIDE COMBINATION MODELS

"A" DIM.	"B" DIM.	"C" DIM.	"D" DIM.	COMBINATION WALK-IN			
				7' - 7"		8' - 7"	
				List	Wt.	List	Wt.
12'	6'	6'	*8'	\$27,756	1646	\$34,677	1797
14'	8'	6'	*8'	\$31,521	1790	\$32,391	1953
16'	8'	8'	*8'	\$32,951	1989	\$33,891	2165
18'	10'	8'	*8'	\$34,161	2133	\$35,176	2321
20'	10'	10'	*8'	\$35,225	2332	\$36,310	2533
22'	12'	10'	*8'	\$39,016	2475	\$40,217	2689
24'	12'	12'	*8'	\$40,429	2674	\$41,704	2900
26'	14'	12'	*8'	\$42,163	2818	\$43,514	3057
28'	14'	14'	*8'	\$43,241	3017	\$44,662	3268
30'	16'	14'	*8'	\$47,006	3161	\$48,546	3424
32'	16'	16'	*8'	\$48,436	3360	\$50,047	3636
34'	18'	16'	*8'	\$49,645	3503	\$51,332	3792
36'	18'	18'	*8'	\$50,705	3702	\$52,466	4004
38'	20'	18'	*8'	\$54,501	3846	\$56,372	4160
40'	20'	20'	*8'	\$55,913	4045	\$57,860	4372

Refrigeration sizing based on 100°F. ambient temperature on all surfaces, outdoor location, (1) 36" x 78" door, **no product load** and 10% safety factor added, 16 hour run time on coolers and 20 hour on freezers. Price includes outdoor membrane roof for outdoor models.

NOTES:

Doors can be located in any standard location on any compartment wall surfaces as shown on STANDARD DOOR LOCATION CHART on page 21. Specify hinging and location when ordering.

For Remote Refrigeration pricing, refer to pages 41-42.



Floor/Floorless Combination Indoor Walk-Ins

LIST PRICING IS FOR PANELS ONLY. REFRIGERATION SYSTEMS MUST BE ADDED SEPARATELY.

INDOOR 9 FOOT WIDE COMBINATION MODELS

"A" DIM.	"B" DIM.	"C" DIM.	"D" DIM.	COMBINATION WALK-IN			
				7' - 7"		8' - 7"	
				List	Wt.	List	Wt.
12'	6'	6'	*9'	\$28,162	1774	\$28,948	1934
14'	8'	6'	*9'	\$32,007	1924	\$32,907	2097
16'	8'	8'	*9'	\$33,543	2137	\$34,514	2322
18'	10'	8'	*9'	\$34,792	2287	\$35,838	2485
20'	10'	10'	*9'	\$35,926	2500	\$37,043	2710
22'	12'	10'	*9'	\$39,793	2650	\$41,029	2873
24'	12'	12'	*9'	\$41,316	2863	\$42,623	3098
26'	14'	12'	*9'	\$43,086	3013	\$44,468	3261
28'	14'	14'	*9'	\$44,238	3226	\$45,690	3486
30'	16'	14'	*9'	\$48,083	3375	\$49,650	3649
32'	16'	16'	*9'	\$49,614	3588	\$51,257	3874
34'	18'	16'	*9'	\$50,864	3738	\$52,581	4037
36'	18'	18'	*9'	\$51,998	3951	\$53,786	4262
38'	20'	18'	*9'	\$55,869	4101	\$57,772	4425
40'	20'	20'	*9'	\$57,388	4314	\$59,365	4650

INDOOR 10 FOOT WIDE COMBINATION MODELS

"A" DIM.	"B" DIM.	"C" DIM.	"D" DIM.	COMBINATION WALK-IN			
				7' - 7"		8' - 7"	
				List	Wt.	List	Wt.
12'	6'	6'	*10'	\$31,265	1902	\$32,130	2072
14'	8'	6'	*10'	\$36,121	2058	\$37,101	2240
16'	8'	8'	*10'	\$37,723	2285	\$38,773	2480
18'	10'	8'	*10'	\$39,047	2441	\$40,173	2648
20'	10'	10'	*10'	\$40,084	2668	\$41,281	2888
22'	12'	10'	*10'	\$44,962	2824	\$46,277	3057
24'	12'	12'	*10'	\$46,551	3051	\$47,937	3296
26'	14'	12'	*10'	\$48,401	3207	\$49,862	3465
28'	14'	14'	*10'	\$49,451	3434	\$50,983	3704
30'	16'	14'	*10'	\$54,307	3590	\$55,953	3873
32'	16'	16'	*10'	\$55,909	3817	\$57,626	4112
34'	18'	16'	*10'	\$57,233	3973	\$59,025	4281
36'	18'	18'	*10'	\$58,271	4200	\$60,133	4521
38'	20'	18'	*10'	\$63,153	4356	\$65,126	4689
40'	20'	20'	*10'	\$64,737	4583	\$66,790	4929

Refrigeration sizing based on 100°F. ambient temperature on all surfaces, outdoor location, (1) 36" x 78" door, **no product load** and 10% safety factor added, 16 hour run time on coolers and 20 hour on freezers. Price includes outdoor membrane roof for outdoor models.

NOTES:

Doors can be located in any standard location on any compartment wall surfaces as shown on STANDARD DOOR LOCATION CHART on page 21. Specify hinging and location when ordering.

For Remote Refrigeration pricing, refer to pages 41-42.



Floor/Floorless Combination Indoor Walk-Ins

LIST PRICING IS FOR PANELS ONLY. REFRIGERATION SYSTEMS MUST BE ADDED SEPARATELY.

INDOOR 11 FOOT WIDE COMBINATION MODELS

"A" DIM.	"B" DIM.	"C" DIM.	"D" DIM.	COMBINATION WALK-IN			
				7' - 7"		8' - 7"	
				List	Wt.	List	Wt.
12'	6'	6'	*11'	\$34,214	2030	\$35,136	2209
14'	8'	6'	*11'	\$39,603	2192	\$40,645	2384
16'	8'	8'	*11'	\$41,161	2433	\$42,278	2637
18'	10'	8'	*11'	\$43,055	2595	\$44,243	2812
20'	10'	10'	*11'	\$44,229	2836	\$45,492	3065
22'	12'	10'	*11'	\$49,645	2999	\$51,023	3240
24'	12'	12'	*11'	\$51,190	3239	\$52,638	3494
26'	14'	12'	*11'	\$53,605	3402	\$55,128	3669
28'	14'	14'	*11'	\$54,797	3643	\$56,390	3922
30'	16'	14'	*11'	\$60,186	3805	\$61,899	4097
32'	16'	16'	*11'	\$61,744	4046	\$63,250	4351
34'	18'	16'	*11'	\$63,638	4208	\$65,496	4525
36'	18'	18'	*11'	\$64,812	4449	\$66,746	4779
38'	20'	18'	*11'	\$70,228	4612	\$72,276	4954
40'	20'	20'	*11'	\$71,773	4852	\$73,892	5207

INDOOR 12 FOOT WIDE COMBINATION MODELS

"A" DIM.	"B" DIM.	"C" DIM.	"D" DIM.	COMBINATION WALK-IN			
				7' - 7"		8' - 7"	
				List	Wt.	List	Wt.
12'	6'	6'	*12'	\$34,854	2158	\$35,834	2346
14'	8'	6'	*12'	\$40,305	2326	\$41,400	2527
16'	8'	8'	*12'	\$41,930	2581	\$43,104	2795
18'	10'	8'	*12'	\$43,881	2750	\$45,125	2976
20'	10'	10'	*12'	\$45,125	3004	\$46,441	3243
22'	12'	10'	*12'	\$50,603	3173	\$52,033	3424
24'	12'	12'	*12'	\$52,214	3428	\$53,720	3692
26'	14'	12'	*12'	\$54,691	3597	\$56,267	3873
28'	14'	14'	*12'	\$55,949	3851	\$57,600	4140
30'	16'	14'	*12'	\$61,400	4020	\$63,166	4321
32'	16'	16'	*12'	\$63,029	4996	\$64,870	4589
34'	18'	16'	*12'	\$64,980	5258	\$66,891	4770
36'	18'	18'	*12'	\$66,225	5519	\$68,207	5037
38'	20'	18'	*12'	\$71,698	5777	\$73,799	5218
40'	20'	20'	*12'	\$73,314	6038	\$75,486	5486

Refrigeration sizing based on 100°F. ambient temperature on all surfaces, outdoor location, (1) 36" x 78" door, **no product load** and 10% safety factor added, 16 hour run time on coolers and 20 hour on freezers. Price includes outdoor membrane roof for outdoor models.

NOTES:

Doors can be located in any standard location on any compartment wall surfaces as shown on STANDARD DOOR LOCATION CHART on page 21. Specify hinging and location when ordering.

For Remote Refrigeration pricing, refer to pages 41-42.



Fast-Trak Options & Accessories

	Part Number	List Price
• Door rain hoods, fits 26", 30" and 36"	032556	\$56
• 26" wide stainless steel exterior kick plate installed (30" high)	123109	\$266
• 26" wide stainless steel interior kick plate installed (30" high)	123110	\$243
• 30" wide stainless steel exterior kick plate installed (30" high)	123111	\$282
• 30" wide stainless steel interior kick plate installed (30" high)	123112	\$259
• 36" wide stainless steel exterior kick plate installed (30" high)	123113	\$283
• 36" wide stainless steel interior kick plate installed (30" high)	123114	\$283
• 26" wide 1/8" aluminum diamond tread exterior kick plate, installed (30" high)	127223	\$400
• 26" wide 1/8" aluminum diamond tread interior kick plate, installed (30" high)	127225	\$290
• 30" wide 1/8" aluminum diamond tread exterior kick plate, installed (30" high)	127226	\$423
• 30" wide 1/8" aluminum diamond tread interior kick plate, installed (30" high)	127228	\$312
• 36" wide 1/8" aluminum diamond tread exterior kick plate, installed (30" high)	127229	\$458
• 36" wide 1/8" aluminum diamond tread interior kick plate, installed (30" high)	127231	\$344
• Exterior ramp for with-floor models	108833	\$871
• 48" LED light fixture (shipped loose)	157752	\$540
• 24" LED light fixture (shipped loose, extended lead time)	157751	\$518
• 9" LED light fixture - 120 volt only (shipped loose)	157750	\$448
• 3" x 3" x 8'-7" angle trim strip	071075	\$54
• 6" x 8' 7" flat trim strip	073070	\$54
• 26" or 30" strip curtain (shipped loose)	103025	\$195
• 36" strip curtain (shipped loose)	103026	\$225
• Non-skid floor strips (shipped loose)	000695	\$10
• 30" interior ramp (allow 10 days for interior ramps)	123116	\$1,485
• 36" interior ramp (allow 10 days for interior ramps)	123117	\$1,568
• 14" x 24" 3-pane unheated viewport with frame heater (allow 10 days)	032457	\$1,590
• 14" x 24" 3-pane heated viewport with heated glass and frame heater (allow 10 days)	032458	\$1,750
• NL708 High/Low Digital Alarm and Light Management System (in lieu of standard NL508 switch)	N/A	\$416



Split-Pak[™] Refrigeration Systems

PRE-ASSEMBLED AND PRE-PIPED WITH SHUT OFF VALVES INSTALLED
(FIELD INTERCONNECTING PIPING AND WIRING REQUIRED)

OUTDOOR/INDOOR SPLIT-PAK[™] REFRIGERATION SYSTEMS

+35°F OPERATION					
CONDENSING UNIT MODEL	SERIES	VOLTAGE	REFRIGERANT	LIST PRICE	NET WARRANTY
MHMD005AB	50	208-230/60/1	R-449A	\$5,021	\$165
MHMD007AB	75-125	208-230/60/1	R-449A	\$5,471	\$165
MHMD010AB	75-125	208-230/60/1	R-449A	\$5,685	\$250
MHMD010AC	75-125	208-230/60/3	R-449A	\$5,685	\$250
MSMD012AB	75-125	208-230/60/1	R-449A	\$6,017	\$330
MSMD012AC	75-125	208-230/60/3	R-449A	\$6,207	\$330
MSMD015AB	150-225	208-230/60/1	R-449A	\$6,502	\$330
MSMD015AC	150-225	208-230/60/3	R-449A	\$6,836	\$330
MSMD017AB	150-225	208-230/60/1	R-449A	\$6,578	\$330
MSMD017AC	150-225	208-230/60/3	R-449A	\$6,522	\$330
MSMD020AB	150-225	208-230/60/1	R-449A	\$6,846	\$330
MSMD020AC	150-225	208-230/60/3	R-449A	\$7,170	\$330

+35°F OPERATION				
EVAPORATOR MODEL	SERIES	VOLTAGE	REFRIGERANT	LIST PRICE
E1MD0060A-TA2	50	115/60/1	R-449A	\$2,599
E1MD0078A-TA2	75-125	115/60/1	R-449A	\$2,748
E1MD0085A-TA2	75-125	115/60/1	R-449A	\$3,093
E1MD0109A-TA2	75-125	115/60/1	R-449A	\$3,474
E1MD0136A-TA2	150-225	115/60/1	R-449A	\$3,631
E1MD0153A-TA2	150-225	115/60/1	R-449A	\$4,053
E1MD0163A-TA2	150-225	115/60/1	R-449A	\$4,539

-10°F OPERATION					
CONDENSING UNIT MODEL	SERIES	VOLTAGE	REFRIGERANT	LIST PRICE	NET WARRANTY
MSLD015AB	100-250	208-230/60/1	R-449A	\$6,703	\$330
MSLD015AC	100-250	208-230/60/3	R-449A	\$6,740	\$330
MSLD017AB	100-250	208-230/60/1	R-449A	\$7,935	\$330
MSLD017AC	100-250	208-230/60/3	R-449A	\$7,916	\$330
MSLD020AB	100-250	208-230/60/1	R-449A	\$7,837	\$330
MSLD020AC	100-250	208-230/60/3	R-449A	\$7,875	\$330
MSLD025AB	100-250	208-230/60/1	R-449A	\$9,584	\$330
MSLD025AC	100-250	208-230/60/3	R-449A	\$9,575	\$330

-10°F OPERATION				
EVAPORATOR MODEL	SERIES	VOLTAGE	REFRIGERANT	LIST PRICE
E1LD0056B-TE2	100-250	208-230/60/1	R-449A	\$3,479
E1LD0076B-TE2	100-250	208-230/60/1	R-449A	\$3,925
E1LD0088B-TE2	100-250	208-230/60/1	R-449A	\$4,037
E1LD0106B-TE2	100-250	208-230/60/1	R-449A	\$4,734



Split-Pak[™] Refrigeration Systems

PRE-ASSEMBLED AND PRE-PIPED WITH SHUT OFF VALVES INSTALLED
(FIELD INTERCONNECTING PIPING AND WIRING REQUIRED)

INDOOR/OUTDOOR SPLIT-PAK[™] REFRIGERATION SYSTEMS - NON-STOCKED UNITS

-10°F OPERATION	CONSULT FACTORY FOR LEAD TIME ON THESE UNITS				
CONDENSING UNIT MODEL	SERIES	VOLTAGE	REFRIGERANT	LIST PRICE	NET WARRANTY
MSLD030AB	-	208-230/60/1	R-449A	\$11,057	\$330
MSLD030AC	-	208-230/60/3	R-449A	\$10,821	\$330
MSLD040AB	-	208-230/60/1	R-449A	\$11,200	\$440
MSLD040AC	-	208-230/60/3	R-449A	\$11,261	\$440
-10°F OPERATION	CONSULT FACTORY FOR LEAD TIME ON THESE UNITS				
EVAPORATOR MODEL	SERIES	VOLTAGE	REFRIGERANT	LIST PRICE	
E1LD0106B-TE2	-	208-230/60/1	R-449A	\$4,734	
E1LD0166B-TE2	-	208-230/60/1	R-449A	\$6,408	

• 5' thru 50' must be specified in 5' increments. When ordering, specify refrigeration system by model number, with the addition of the letter "Q", followed by a dash and the line length desired. The total list price is the addition of the base refrigeration system and line length desired.

NOTE: Care should be taken to order only the length of lines required.

Custom Built Coolers, Freezers Or Combination Coolers/Freezers

Features

- Cooler, freezer or combination cooler/freezer models, multiple compartments and warehouse buildings
- Glass doors or special doors
- Specify any size
- Specify any shape or angle
- Specify any height
- Specify any color
- Specify exterior metal finish
- Specify interior finish
- Adjustable spring loaded hinge
- Spring actuated door closer
- Digital thermometer and light switch
- Standard deadbolt locking handle
- Kickplate
- 15 year panel warranty – industry leading

Options

- Finish options:
 - 26 ga. corrosion resistant stucco embossed coated steel
 - 26 ga. Embossed painted steel
 - .040 embossed aluminum
 - 22 ga. smooth painted steel
 - 22 ga. stainless steel
 - 22 ga. smooth galvanized
- Bumper rails, trim strips and closure panels
- Viewports (freezer ports heated)
- Indoor and outdoor roof and ceiling support systems
- Interior and exterior door kickplates (shipped loose)
- Interior and exterior ramps
- Additional LED Lighting
- Digital alarm and light management system
- Selection of interior and exterior surfaces and finishes
- Special floor underlayments and topside plating
- Various door styles and sizes
- Various security alarm systems
- Wide range of computer sized and balanced refrigeration systems
- Specially designed shelving kits



**Contact Norlake For Your
Fineline Walk-In Quote
800-955-5253**



WARRANTIES

Walk-In/Refrigeration Warranties

FIFTEEN YEAR ORIGINAL EQUIPMENT PANEL WARRANTY **No Charge**
Covering all Norlake, Inc. foam walk-in room panels. Warranty covers the repair or replacement with a like panel of any original equipment panel which proves defective, at Norlake's option.

18-MONTH ORIGINAL EQUIPMENT PARTS WARRANTY **No Charge**
Covering all Norlake, Inc. commercial refrigeration products. Warranty covers the repair or replacement with a like part of any original equipment part which proves defective, at Norlake's option.

18-MONTH LABOR/SERVICE WARRANTY **No Charge**
Covering all Norlake, Inc. self contained commercial refrigeration products. Warranty covers the reasonable labor cost, on a straight time basis, to repair the warranted product which proves defective. Excludes service calls for minor operational adjustment. NOTE: Does not apply to remote refrigeration systems requiring electrical inter-wiring or refrigerant piping provided by others.

FIVE YEAR (FOUR YEAR EXTENSION) ORIGINAL COMPRESSOR WARRANTY (OP5YW) **(Net Price)**
Covering all Norlake, Inc. refrigeration systems. Warranty covers the repair or replacement with a like compressor (the original equipment compressor only) for the warranted product which proves defective, at Norlake's option. Mandatory on all installed sealed units unless prior arrangements have been made. Available at the following prices:

SPLIT-PAK REMOTE SYSTEMS: See pages 50-51

CAPSULE PAK SYSTEMS

- CPB050 \$165 • CPB100 \$250 • CPF100 \$250 • CPF200 \$330
- CPB075 \$165 • CPF075 \$165 • CPF150 \$330

NINETY-DAY REPLACEMENT PARTS WARRANTY **No Charge**
Covering all Norlake, Inc. commercial refrigeration products. Warranty covers the repair or replacement with like replacement part only of the warranted product which proves defective, at Norlake's option.

Refrigerated Cabinet Warranties

THREE YEAR ORIGINAL EQUIPMENT PARTS WARRANTY **No Charge**
Covering Norlake, Inc. commercial refrigerated AdvantEDGE™ products. Warranty covers the repair or replacement with a like part of any original equipment part which proves defective, at Norlake's option.

THREE YEAR LABOR/SERVICE WARRANTY **No Charge**
Covering Norlake, Inc. self-contained commercial refrigerated AdvantEDGE™ products. Warranty covers the reasonable labor cost, on a straight time basis, to repair the warranted product which proves defective. Excludes service calls for minor operational adjustment. NOTE: Does not apply to remote refrigeration systems requiring electrical inter-wiring or refrigerant piping provided by others.

TWO YEAR ORIGINAL EQUIPMENT PARTS WARRANTY **No Charge**
Covering Norlake, Inc. commercial refrigerated ice cream products. Warranty covers the repair or replacement with a like part of any original equipment part which proves defective, at Norlake's option.

TWO YEAR LABOR/SERVICE WARRANTY **No Charge**
Covering Norlake, Inc. self-contained commercial refrigerated ice cream products. Warranty covers the reasonable labor cost, on a straight time basis, to repair the warranted product which proves defective. Excludes service calls for minor operational adjustment. NOTE: Does not apply to remote refrigeration systems requiring electrical inter-wiring or refrigerant piping provided by others.

ONE YEAR ORIGINAL EQUIPMENT PARTS WARRANTY **No Charge**
Covering Norlake, Inc. commercial refrigerated countertop merchandisers and display freezers. Warranty covers the repair or replacement with a like part of any original equipment part which proves defective, at Norlake's option.

ONE YEAR LABOR/SERVICE WARRANTY **No Charge**
Covering Norlake, Inc. self contained commercial refrigerated countertop merchandisers. Warranty covers the reasonable labor cost, on a straight time basis, to repair the warranted product which proves defective. Excludes service calls for minor operational adjustment. NOTE: Does not apply to remote refrigeration systems requiring electrical inter-wiring or refrigerant piping provided by others.

FIVE YEAR ORIGINAL COMPRESSOR WARRANTY **No Charge**
Covering all Norlake, Inc. refrigerated cabinets. Warranty covers the repair or replacement with a like compressor (the original equipment compressor only) for the warranted product which proves defective, at Norlake's option. Mandatory on all installed sealed units unless prior arrangements have been made.

NINETY DAY REPLACEMENT PARTS WARRANTY **No Charge**
Covering all Norlake, Inc. commercial refrigeration products. Warranty covers the repair or replacement with like replacement part only of the warranted product which proves defective, at Norlake's option.

Refer to warranty certificate for complete warranty information.

Warranty Summary

EQUIPMENT MODELS	COVERAGE
Display freezer models MSC-AN/CTB, MSF-AN/FTB	One year parts and labor
Countertop merchandiser models MBCTM/NLCTM	One year parts and labor
Ice cream cabinet models DC/FF, DD/HF & FLR/ZF	Two year parts and labor, five year compressor
Endless BEM/BEL models with remote refrigeration systems	Two year parts and labor on cabinet with 18 months parts and labor on condensing unit with an optional compressor warranty extending to five years
Endless BEM/BEL-SC semi-self-contained models	Two year parts and labor, five year compressor
Solid door reach-in models MBF/NLF, MBR/NLR, MBR-G/NLR-G, MBTF/NLTF, MBTR/NLTR	Three year parts and labor, five year compressor
Glass door merchandiser models MBFGM/NLFGM, MBRGM/NLRGM	Three year parts and labor, five year compressor
Prep table models MBSP/NLSP, MBSMP/NLSMP, MBPT/NLPT	Three year parts and labor, five year compressor
Undercounter refrigerator and freezer models MBUR/NLUR, MBUF/NLUF	Three year parts and labor, five year compressor
Chef base models MBCB/NLCB	Three year parts and labor, five year compressor
Bottle cooler models MBBC/NLBC	Three year parts and labor, five year compressor
Back bar refrigerator models MBBB/NLBB, MBBB-G/NLBB-G	Three year parts and labor, five year compressor
Shallow depth back bar refrigerator models MBBB-N/NLBB-N, MBBB-NG/NLBB-NG	Three year parts and labor, five year compressor
Direct draw beer coolers MBDD/NLDD	Three year parts and labor, five year compressor
Milk cooler models MBMC/NLMC	Three year parts and labor, five year compressor
All Master-Bilt and Norlake walk-ins	18 months parts and labor, 15 year panel
Split-Pak™ remote refrigeration (MSLD, MHMD & MSMD models)	18 months parts and labor with an optional compressor warranty extending to five years
Capsule Pak™ self-contained refrigeration systems (CP and RCP models)	18 months parts and labor with an optional compressor warranty extending to five years
Multi-compressor refrigeration system models MRS and DRS	One year parts and labor, five year compressor warranty



TERMS & CONDITIONS

1. **NATURE OF DOCUMENT.** This document constitutes the acceptance of the members of Norlake, Incorporated ("Seller") to sell the products specified on the reverse side (the "Products") on the terms and conditions contained herein, however, acceptance is made expressly conditional on the Buyer's agreement to all of the terms and conditions contained herein. Seller's acceptance of a purchase order from the Buyer shall not constitute acceptance of any of the terms and conditions thereon which differ from these terms, except as the Seller may otherwise specify in writing. Such different or conflicting terms are expressly rejected by Seller.
2. **CHANGES AND CANCELLATION.** Seller shall have the right to terminate, modify and/or cancel the contract for sale of the Products at any time Seller determines that Buyer's credit is not satisfactory or for any other reason in Seller's reasonable commercial judgment. Any such termination or cancellation shall be effective upon notification (orally or in writing) to Buyer and shall be without liability to the Seller. Under no circumstances shall Buyer have the right to terminate the contract or cancel its order to purchase the Products, without written authorization by the Seller. All cancelled orders and returned goods will be subject to a minimum of 25% cancellation and/or restocking charge. Custom or modified units cannot be returned.
3. **PRICES.** Unless otherwise indicated, prices are F.O.B. Seller's facility, and do not include any sales, use, excise or similar taxes or duties now or hereafter imposed. Errors or omissions in prices are subject to correction. Prices are subject to change without notice prior to shipment.
4. **PAYMENT.** Unless otherwise indicated, payment terms are net cash 30 days from date of shipment. In the event that the Buyer fails to make payment on time, Buyer shall be liable to Seller for the lesser of (a) 1.5% per month on the remaining balance or (b) the highest monthly interest rate which may lawfully be charged to Buyer. Buyer shall be liable for all expenses (including reasonable attorneys' fees) incurred by Seller in collecting or attempting to collect any amounts due to Seller under the contract.
5. **TITLE, RISK OF LOSS.** Title to, and risk of loss of, the Products shall pass to Buyer upon the delivery of the Products F.O.B. Seller's facility to an agent of Buyer or to a common carrier.
6. **INSPECTION.** If, upon receipt of the Products by Buyer at the destination, the same shall appear not to conform to the order, Buyer shall within seven (7) days after receipt thereof, notify Seller of such condition and afford Seller a reasonable opportunity to inspect the Products and make the appropriate adjustments, repair or replacement. The remedies afforded under Section 7 below shall be exclusive for any defects discovered in the Products and which could have been discovered upon inspection. If the Seller is not so notified, the Buyer waives any recourse for those defects, and all warranty obligations of Seller regarding such obvious defects or deficiencies shall terminate.
7. **LIMITED WARRANTIES AND REMEDIES.** Seller warrants that, at the time of shipment, the Products will be free from defects in material and workmanship to the original purchaser-user for a period no longer than one year from original installation by an authorized representative or one year and three months from shipment, under conditions of normal use and recommended maintenance. Written notice of a claim under this warranty must be received by Seller before the expiration of such period in order for warranty coverage to apply.

If notice of a claim is timely made, Seller will repair or replace the Product or part which is defective (at Seller's sole option) either at the user's facility or at Seller's plant, as Seller shall decide. If Seller decides that a Product or part should be returned to its plant, the Buyer or user shall have the following obligations:

 - (a) removal of any parts to be returned;
 - (b) identification of all parts with tags stating the model number and serial number of the Products on which the part is used;
 - (c) shipment of Products and/or parts, transportation prepaid, to Seller's plant;
 - (d) installation of the repaired or replaced Product or parts at user's facility.

This Warranty shall not apply to the extent that Products or parts have been used other than in conformance with operating or maintenance instructions, subjected to misuse or abuse, damaged by accident, act of God, abnormal use or stress or any other matter unrelated to Seller and beyond its reasonable control or altered or modified by third parties.

THIS WARRANTY IS EXCLUSIVE AND IS IN LIEU OF ALL OTHER WARRANTIES, EXPRESS OR IMPLIED, INCLUDING THE IMPLIED WARRANTIES OF MERCHANTABILITY AND FITNESS FOR PURPOSE. IN NO EVENT SHALL THE COMPANY BE LIABLE FOR LOSS OF USE, REVENUE OR PROFIT OR FOR ANY OTHER INCIDENTAL, SPECIAL OR CONSEQUENTIAL DAMAGE, INCLUDING, BUT NOT LIMITED TO, FOOD SPOILAGE AND PRODUCT LOSS.
8. **LIMITATION OF LIABILITY.** The liability of Seller arising out of the manufacture, sale, delivery, repair, or use of any of the Products shall not, in any event, exceed the cost of correcting defects or making replacement as required in the Limited Warranty and, upon the expiration of the Limited Warranty, all liability of Seller to Buyer and any end user shall terminate.
9. **DELAYS.** Neither party shall be liable for any delay or failure to perform any obligation to the other if such delay or failure shall be caused by an event or contingency beyond its reasonable control, irrespective of the nature thereof, however, the delaying party shall endeavor to correct such delay as soon as reasonably practicable.



TERMS & CONDITIONS

10. **MODIFICATION; ASSIGNMENT; APPLICABLE LAW; ENTIRE AGREEMENT.** No modification of the terms and conditions specified in the contract shall be binding upon Seller unless agreed to by Seller in writing. The contract shall not be assigned by Buyer, nor may any of the duties of Buyer or User thereunder be delegated, without the written consent of Seller. Any such assignment or delegation without such consent shall be void. The contract shall be governed by, and construed in accordance with, the laws of the State of Delaware. The provisions of the contract shall constitute the entire agreement of the parties with respect to the sale of the Products by Seller to Buyer and shall supersede all prior discussion and writings between the parties.
11. **BINDING EFFECT OF CONTRACT.** The contract shall be binding upon, and shall inure to the benefit of the parties hereto and their respective successors and assigns.
12. **RETURNS.** No returns will be accepted without the prior approval of the Seller. A Return Authorization Number must be given by Seller prior to Products being shipped, freight prepaid, by Buyer. Any damage in transit to Products being returned is Buyer's responsibility. All accepted returns are subject to a 25% restocking charge. Returns that have been approved by Seller must be received within thirty (30) days after approval. Returns will not be considered after ninety (90) days from date of original notice.
13. **FREIGHT DAMAGES.** Claims for damages must be filed at once by purchaser with the freight carrier although as a service to our customers we may act as their agent in seeking reimbursement under the applicable carrier insurance policy for the damage caused to the product in transit. Note: Any differences between the amount of the claim filed and the money received is a valid receivable that is the responsibility of the customer to remit to Norlake, Incorporated.
14. **INDEMNITY.** Buyer or User agrees to indemnify, hold harmless and defend Seller from and against any and all liabilities and expenses arising out of any injury or damage which results from Buyer's or User's improper or abnormal use, misuse, misapplication, failure to inspect, maintain or repair the Products which are the subject of this agreement.

NORLAKE QUALITY POLICY

Our objective is to pursue, earn and maintain a reputation of quality leadership and ethical integrity among the customers we serve.

Their opinion of us will be measured in all areas of service contact and product quality and it will be used as a basis for continued quality improvement.





REPRESENTATIVES

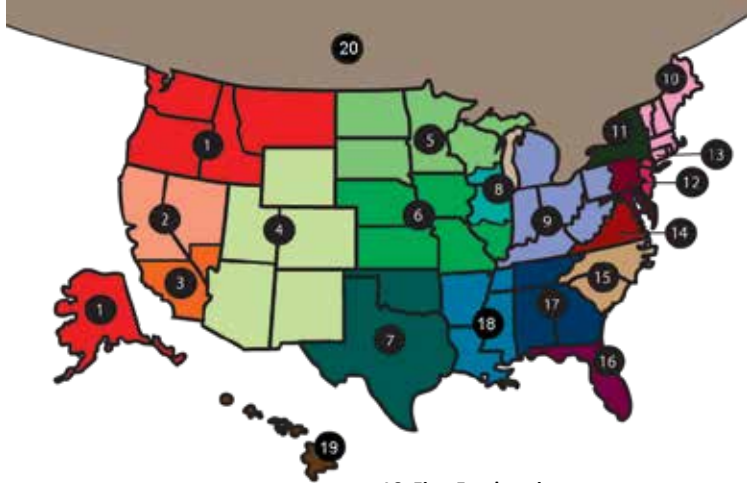

1. Voeller & Associates

- 4723 Lakehurst Lane
Bellevue, WA 98006
- 425-644-7432
- joan@voeller.com

Covers: *Washington, Oregon, Idaho, Montana & Alaska*

2. Eagle/Frizzell & Associates

- 555 Peters Ave., Suite 250
Pleasanton, CA 94566
- 925-249-1450
- office@eaglefrizzell.com

Covers: *Northern California & Nevada excluding Clark County)*

3. Integra Marketing

- 15613 S. Blackburn Ave.
Norwalk, CA 90650
- 562-229-0404
- tom@integra-marketing.com

Covers: *Southern California & Clark County in Nevada*

4. Tom Redditt Sales Agency

- 3131 West 14th Ave.
Denver, CO 80204
- 303-571-5100
- lance@redditt.org

Covers: *Arizona, Colorado, Utah, Wyoming, New Mexico & El Paso, TX*

5. Daly & DeRoma Group, Inc.

- 18200 45th Ave North, Suite C
Plymouth, MN 55446
- 877-325-9477 or 763-543-8080
- info@dalyderoma.com

Covers: *Minnesota, North Dakota, South Dakota*

6. Cre8tive Hospitality Solutions

- 12730 State Line Rd
Leawood, KS 66209
- 913-764-5558
- shoenninger@cre8tivehs.com

Covers: *Iowa, Missouri, Kansas, Nebraska, Southern Illinois*

7. LMS Associates

- 2205 W. Division Street, Suite A9
Arlington, TX 76012
- 800-725-7377
- kim@lmsassociates.com

Covers: *Texas, Oklahoma*

8. Hanna-Young & Associates

- 240 James Street
Bensenville, IL 60106
- 630-227-9900
- tyoung@hannayoung.com

Covers: *Chicago and Northern Illinois*

9. 2Market Group

- 285-A Old County Line Road
Westerville, OH 43081
- 877-621-3800
- nina@twomarket.com

Covers: *Ohio, Kentucky, West Virginia, Indiana, Western Pennsylvania, Michigan*

10. Viola Group

- One Orchard Park #11
Madison, CT 06443
- 203-245-0711
- pamela@violagroup.com

Covers: *Connecticut, New Hampshire, Rhode Island, Vermont, Maine, Massachusetts*

11. Commercial Kitchen Reps

- 320 N. Washington St.
Rochester, NY 14625
- 585-249-0520
- dgraf@ckreps.com

Covers: *Upstate New York*

12. Starliper & Associates

- 2570 New Schuykill Road
Parker Ford, PA 19457
- 610-363-5688
- office@starliperassociates.com

Covers: *Eastern Pennsylvania, Southern New Jersey & Delaware*

13. Clements-Stella-Gallagher Marketing

- 217 Rock House Road
Easton, CT 06612
- 631-758-5316
- LauraL@csgmfoodequip.com

Covers: *City of New York, Long Island, Westchester & Rockland Counties, Northern New Jersey*

14. ASM - Market First

- 5085 Vest Lane
Waldorf, MD 20601
- 301-870-8861
- info@asm-dmv.com

Covers: *Washington, D.C., Maryland and Virginia*

15. Associated Marketing Agents

- 305 Brookridge Drive
Mt. Holly, NC 28120
- 919-624-8351
- mark@amaofthecarolinas.com

Covers: *North Carolina & South Carolina*

16. Finn Foodservice

- 14605 McCormick Drive
Tampa, FL 33626
- 800-451-6755
- matt@finnfs.com

Covers: *Florida excluding Panhandle)*

17. Cutting Edge Marketing Agents

- 109 Smokehill Lane, Suite 130
Woodstock, GA 30188
- 770-694-6390
- kgibson@cuttingedgereps.com

Covers: *Alabama, Georgia, Tennessee, Florida Panhandle*

18. Velkey & Associates

- 880 Breckenridge Lane
Savannah, TN 38372
- 731-412-7085
- mark@velkey.net

Covers: *Arkansas, Louisiana, Mississippi*

19. Van Cleave Marketing

- 600 Queen Street #3002
Honolulu, HI 96813
- 808-375-3820
- VanCleaveMktg@gmail.com

Covers: *Hawaii*

20. Bill Smith Marketing, Ltd.

- 67 Chaparral Common S.E.
Calgary, Alberta, CN T2X 3N8
- 403-238-7893
- billsmithbsml@shaw.ca

Covers: *Western Canada*

21. Trillium Sales & Marketing

- 153 Jessie Court
Ancaster, Ontario, CN L9G 3R6
- 416-464-7141
- trilliumsales@gmail.com

Covers: *Eastern Canada*

22. Davis & Associates

- W184 S8372 Challenger Drive
Muskego, WI 53150
- 888-679-9510
- customerservice@davisassoc.com

Covers: *Wisconsin & Upper Michigan*